

PRL GLASS SYSTEMS PANIC HANDLES

FOR TEMPERED GLASS, FULL FRAME AND WOOD DOORS



PL100A

PL101A

PL102A

PRL GLASS SYSTEMS

PANIC HANDLE CONFIGURATIONS

 PRL Glass systems inc.
251 Mason way
City of industry, CA. 91746
Phone: 800-433-7044
Fax: 626-968-9256
www.prlglass.com

PANIC HANDLES

FOR TEMPERED GLASS, FULL FRAME AND WOOD DOORS

Leading the Industry in Proven Custom Architectural Glass and Metal Door Hardware.

PRL is now offering 2 NEW completely revolutionary, adaptable glass door panic systems.

PL 100

PL 110.

Glass Door Panic System

Both Series of Panic Door Systems accentuate glass entrance doors with its contemporary, minimal 1-1/4" tubular housing to accommodate over 100 precision and manufactured fitting components engineered and mechanically synchronized for a safe panic function.

Many door style configurations that include narrow full frame entrances and custom applications are available, choose from a wide range of contemporary exterior pulls and adaptable handles, custom TVS header, an electric strike can also be utilized with this glass panic door system and work in conjunction with a remote key less application, please consult PRL for details.

The **PL 100** panic door device can also be dogged by sliding a pin located below the cylinder housing which allows the panic system to remain in an open position giving free access during business hours. An electric strike can also be utilized with this glass panic door system and work in conjunction with a remote key less application.

Note: PRL manufactures two types of glass door panic systems; PL 100 for top latch and PL 110 for floor latching panic device applications. State and Local building codes may require top latch for A.D.A. compliance.

•Thresholds are recommended on floor strike system as floor mounted strikes can be a tripping hazard.

PL110 is a contemporary panic door handle design primarily for glass door entrance systems - panics can be manufactured to be installed on wood and aluminum doors as well, please consult factory for specifications. The slim 1 1/4" diameter interior panic bar system conceals the latching mechanism allowing minimal uninterrupted view on 1/2" or 3/4" glass.

The PL 110 panic door device can also be dogged by sliding a pin located below the cylinder housing which allows the panic system to remain in an open position giving free access during business hours. An electric strike can also be utilized with this glass panic door system and work in conjunction with a remote key less application.

Note: State and Local building codes may require top latch for A.D.A. compliance. Please see PRL Glass Door Panic System PL 100 Series for all your top latching panic device applications.

•Thresholds are recommended on floor strike system as floor mounted strikes can be a tripping hazard.



PRL GLASS SYSTEMS

PANIC HANDLE CONFIGURATIONS

 PRL Glass systems inc.
251 Mason way
City of industry, CA. 91746
Phone: 800-433-7044
Fax: 626-968-9256
www.prlglass.com

PANIC HANDLES

FOR TEMPERED GLASS, FULL FRAME AND WOOD DOORS



PRL GLASS SYSTEMS

ARCHITECTURAL HANDLE

CONFIGURATIONS

 PRL Glass systems inc.
251 Mason way
City of industry, CA. 91746
Phone: 800-433-7044
Fax: 626-968-9256
www.prlglass.com



Handle A

Handle B

Handle C

Handle D

Handle E

Handle F

Handle G

Handle H



Handle J

Handle J-S

Handle K

Handle K-S

Handle L

Handle L-S

Handle M

Handle M-S



Handle N

Handle P

Handle X

Handle Y

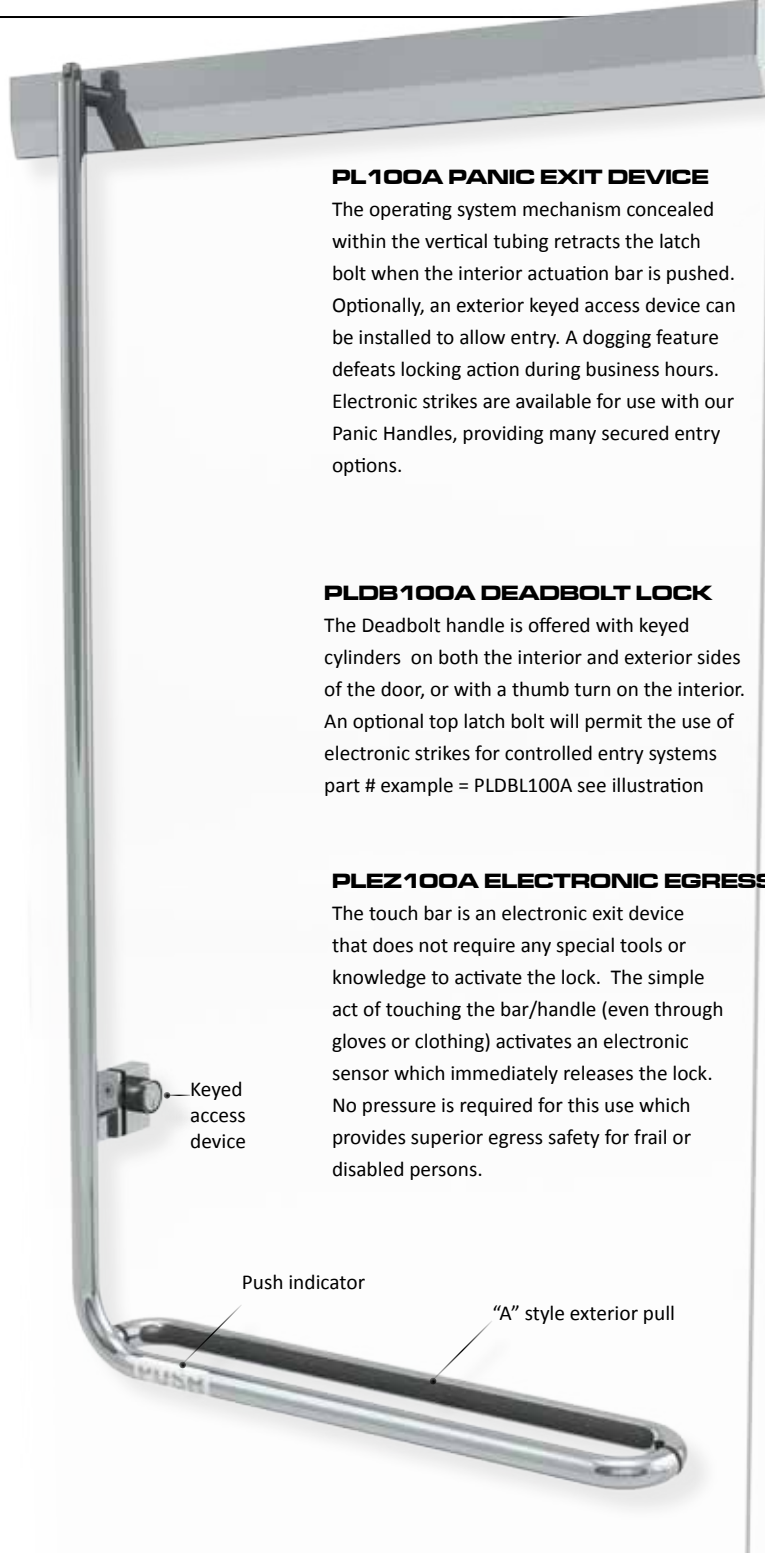

PL100A PANIC EXIT DEVICE

The operating system mechanism concealed within the vertical tubing retracts the latch bolt when the interior actuation bar is pushed. Optionally, an exterior keyed access device can be installed to allow entry. A dogging feature defeats locking action during business hours. Electronic strikes are available for use with our Panic Handles, providing many secured entry options.

PLDB100A DEADBOLT LOCK

The Deadbolt handle is offered with keyed cylinders on both the interior and exterior sides of the door, or with a thumb turn on the interior. An optional top latch bolt will permit the use of electronic strikes for controlled entry systems part # example = PLDBL100A see illustration

PLEZ100A ELECTRONIC EGRESS

The touch bar is an electronic exit device that does not require any special tools or knowledge to activate the lock. The simple act of touching the bar/handle (even through gloves or clothing) activates an electronic sensor which immediately releases the lock. No pressure is required for this use which provides superior egress safety for frail or disabled persons.

PLDH100A DUMMY HANDLE

These fixed handles are designed to match the appearance of Panic, Deadbolt, and Electronic Egress Handles, and are made from the same high quality materials.



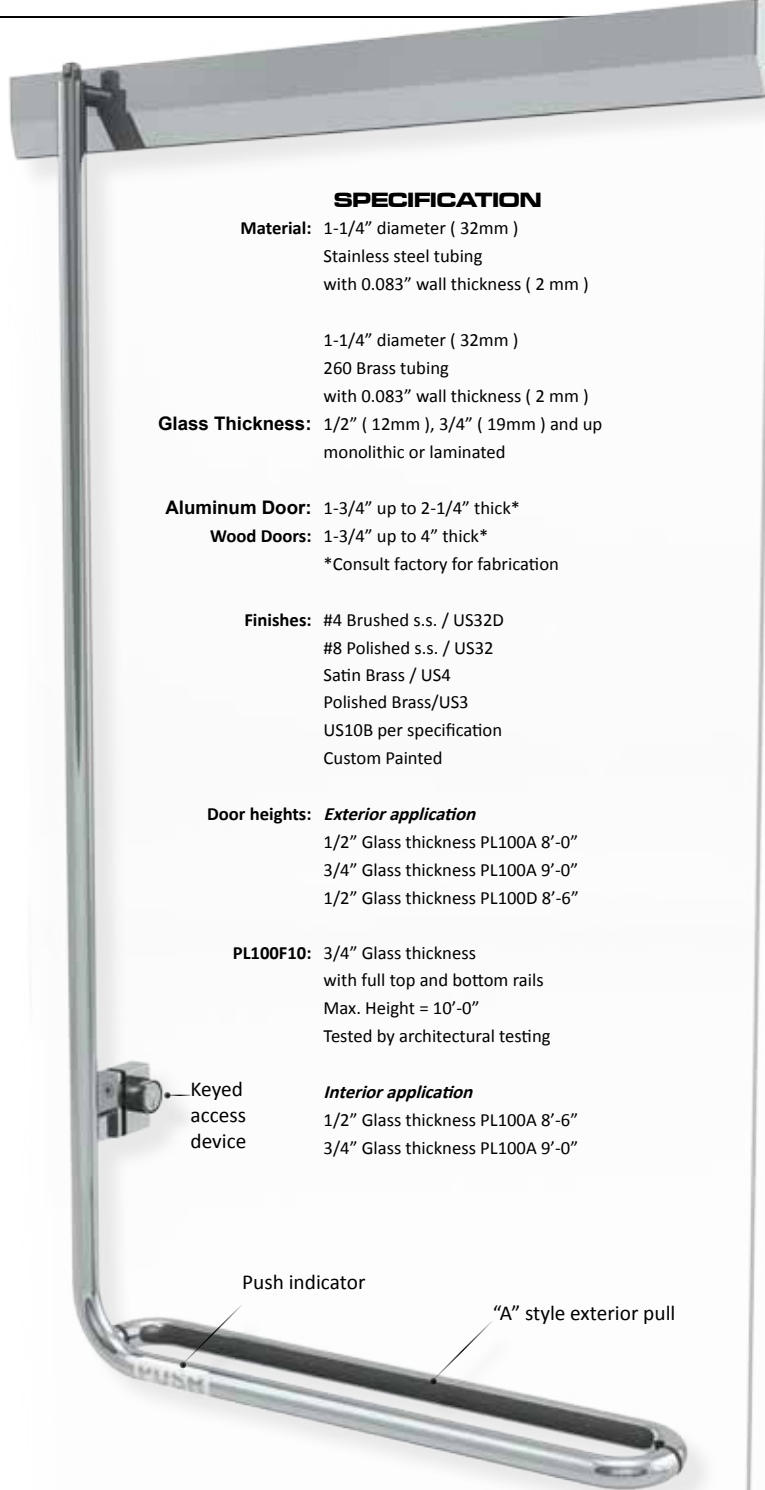

SPECIFICATION

Material: 1-1/4" diameter (32mm)
Stainless steel tubing
with 0.083" wall thickness (2 mm)

1-1/4" diameter (32mm)
260 Brass tubing
with 0.083" wall thickness (2 mm)

Glass Thickness: 1/2" (12mm), 3/4" (19mm) and up
monolithic or laminated

Aluminum Door: 1-3/4" up to 2-1/4" thick*

Wood Doors: 1-3/4" up to 4" thick*
*Consult factory for fabrication

Finishes: #4 Brushed s.s. / US32D
#8 Polished s.s. / US32
Satin Brass / US4
Polished Brass/US3
US10B per specification
Custom Painted

Door heights: Exterior application
1/2" Glass thickness PL100A 8'-0"
3/4" Glass thickness PL100A 9'-0"
1/2" Glass thickness PL100D 8'-6"

PL100F10: 3/4" Glass thickness
with full top and bottom rails
Max. Height = 10'-0"
Tested by architectural testing

Interior application
1/2" Glass thickness PL100A 8'-6"
3/4" Glass thickness PL100A 9'-0"

Keyed
access
device

Push indicator

"A" style exterior pull

Certification: ANSI/BHMA A156.3 - 2008 Grade 1
Cycle: 500,000 Max Approved By UL
1.3 million tested by Architectural testing

PL-100 Panics device and PLDB deadbolts
are all furnished with removable core
Custom collars are available to accommodate
cylinders with different lengths

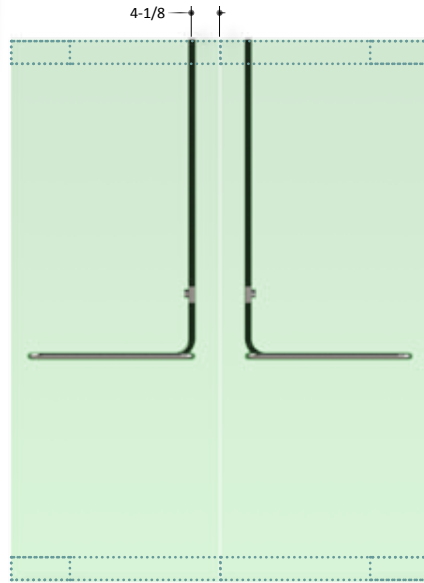

Exception

Maximum height for 1/2" glass doors is 108"
tall when using "F" style exterior handle

Increased sizes make the door assemblies heavier and more
flexible.

Therefore, the following guidelines should be considered:

- Wind load, stack action and ventilation loads
- Mounting conditions of doors to building structure
- Panic devices, Deadbolt locks or other hardware
- Overhead closer or floor closer characteristics
- Heavy usage and frequency of operation
- Comfortable feel and ease of door operation

The architect's structural engineer should be consulted to
assure that the door design is correct to the intended use



The following list of mortise cylinders will work with PRL Panics and Deadbolts

MFR.	NO.	NOMINAL LENGTH	CAM NO.
Schlage	20-001	1-1/8"	B502-191
Russwin	#0 1/2"	1-1/8"	#1
Corbin	5253	1-1/8"	#1
Sargent	41	1-1/8"	X13000
Best	1E64	1-1/8"	1EC4
Yale	1152	1-1/8"	1161 (std.)
Lori	218	1-1/8"	4400-00-3002

Removable core mortise cylinders and thumb-turns will function properly when fitted with one of the listed straight cams. Custom cylinder collars are available to accommodate cylinder lengths exceeding 1-1/8"

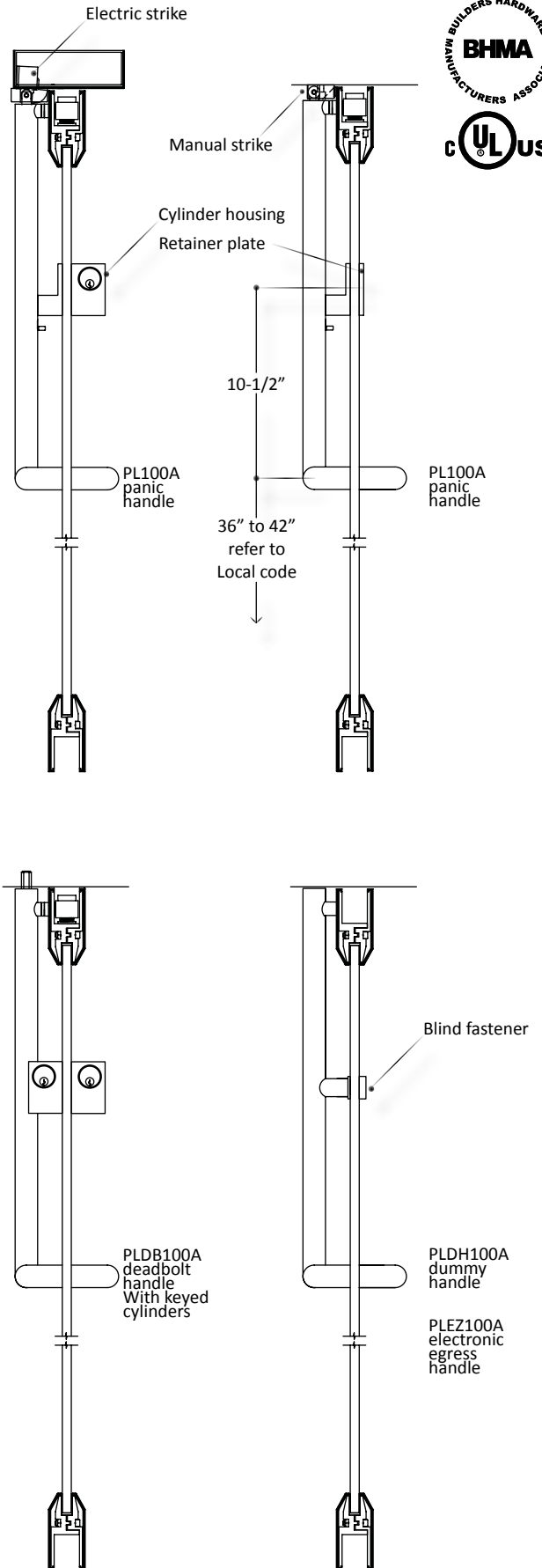
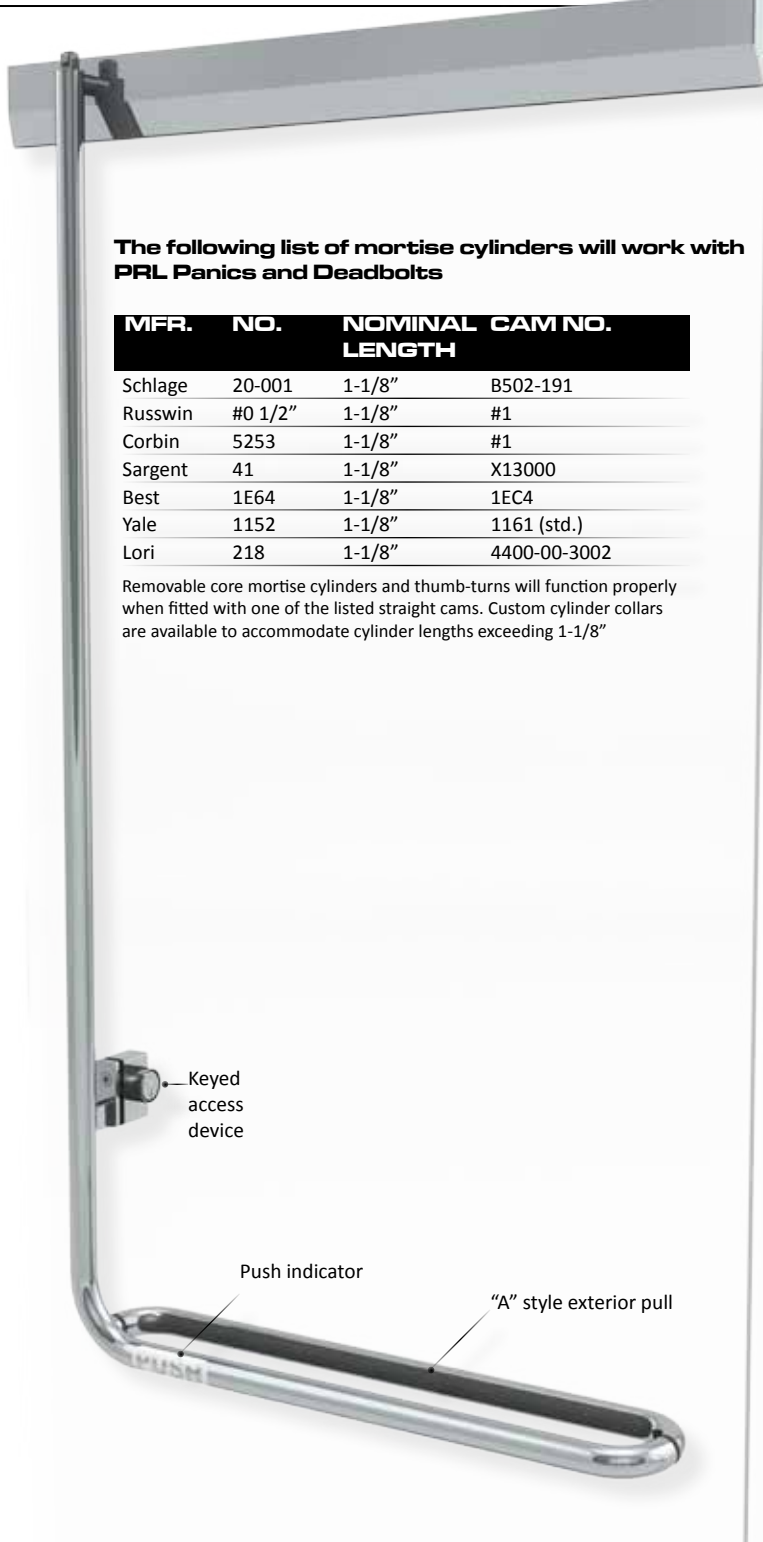



PL100D PANIC EXIT DEVICE

The operating system mechanism concealed within the vertical tubing retracts the latch bolt when the interior actuation bar is pushed. Optionally, an exterior keyed access device can be installed to allow entry. A dogging feature defeats locking action during business hours. Electronic strikes are available for use with our Panic Handles, providing many secured entry options.

PLDB100D DEADBOLT LOCK

The Deadbolt handle is offered with keyed cylinders on both the interior and exterior sides of the door, or with a thumb turn on the interior. An optional top latch bolt will permit the use of electronic strikes for controlled entry systems.

PLEZ100D ELECTRONIC EGRESS

The touch bar is an electronic exit device that does not require any special tools or knowledge to activate the lock. The simple act of touching the bar/handle (even through gloves or clothing) activates an electronic sensor which immediately releases the lock. No pressure is required for this use which provides superior egress safety for frail or disabled persons.

Push indicator

"D" style exterior pull

PLDH100D DUMMY HANDLE

These fixed handles are designed to match the appearance of Panic, Deadbolt, and Electronic Egress Handles, and are made from the same high quality materials.



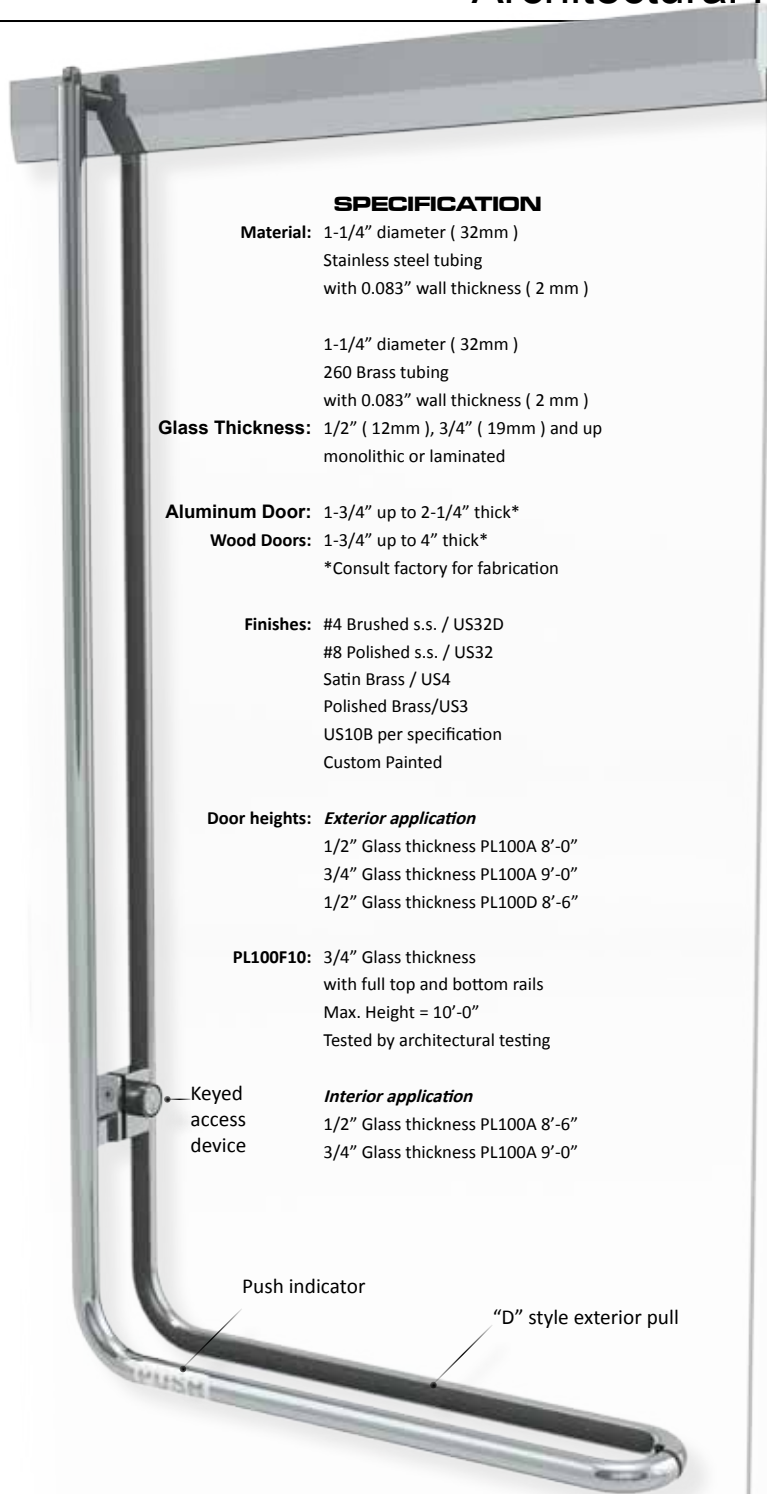

SPECIFICATION

Material: 1-1/4" diameter (32mm)
Stainless steel tubing
with 0.083" wall thickness (2 mm)

1-1/4" diameter (32mm)
260 Brass tubing
with 0.083" wall thickness (2 mm)

Glass Thickness: 1/2" (12mm), 3/4" (19mm) and up
monolithic or laminated

Aluminum Door: 1-3/4" up to 2-1/4" thick*

Wood Doors: 1-3/4" up to 4" thick*
*Consult factory for fabrication

Finishes: #4 Brushed s.s. / US32D
#8 Polished s.s. / US32
Satin Brass / US4
Polished Brass/US3
US10B per specification
Custom Painted

Door heights: Exterior application
1/2" Glass thickness PL100A 8'-0"
3/4" Glass thickness PL100A 9'-0"
1/2" Glass thickness PL100D 8'-6"

PL100F10: 3/4" Glass thickness
with full top and bottom rails
Max. Height = 10'-0"
Tested by architectural testing

Keyed
access
device

Interior application
1/2" Glass thickness PL100A 8'-6"
3/4" Glass thickness PL100A 9'-0"

Push indicator

"D" style exterior pull

Certification: ANSI/BHMA A156.3 - 2008 Grade 1
Cycle: 500,000 Max Approved By UL
1.3 million tested by Architectural testing

PL-100 Panics device and PLDB deadbolts
are all furnished with removable core
Custom collars are available to accommodate
cylinders with different lengths

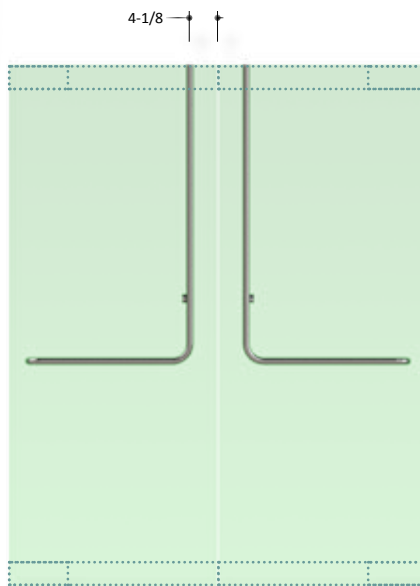

Exception

Maximum height for 1/2" glass doors is 108"
tall when using "F" style exterior handle

Increased sizes make the door assemblies heavier and more
flexible.

Therefore, the following guidelines should be considered:

- Wind load, stack action and ventilation loads
- Mounting conditions of doors to building structure
- Panic devices, Deadbolt locks or other hardware
- Overhead closer or floor closer characteristics
- Heavy usage and frequency of operation
- Comfortable feel and ease of door operation

The architect's structural engineer should be consulted to
assure that the door design is correct to the intended use

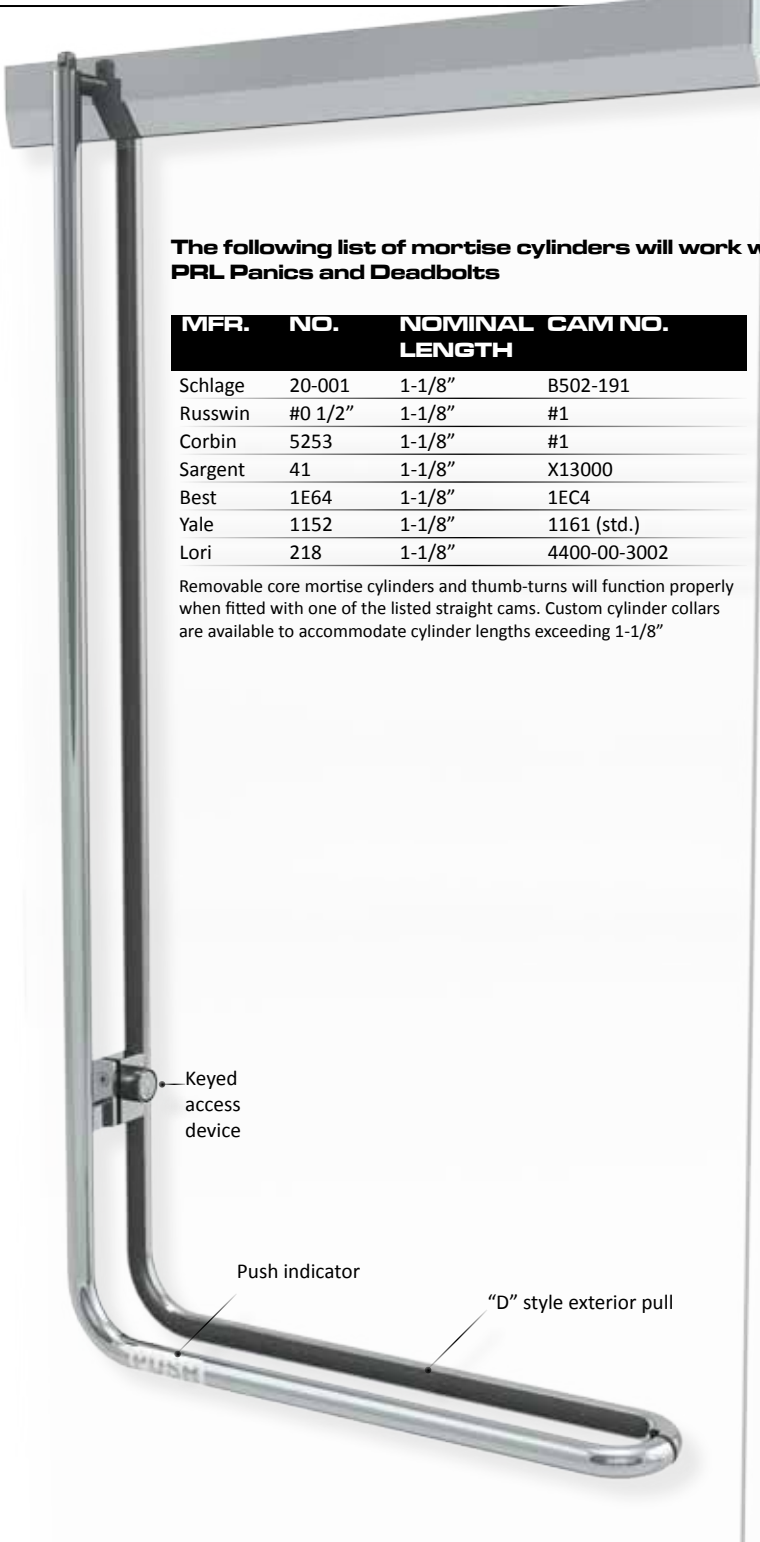

The following list of mortise cylinders will work with PRL Panics and Deadbolts

MFR.	NO.	NOMINAL CAM NO.	LENGTH
Schlage	20-001	1-1/8"	B502-191
Russwin	#0 1/2"	1-1/8"	#1
Corbin	5253	1-1/8"	#1
Sargent	41	1-1/8"	X13000
Best	1E64	1-1/8"	1EC4
Yale	1152	1-1/8"	1161 (std.)
Lori	218	1-1/8"	4400-00-3002

Removable core mortise cylinders and thumb-turns will function properly when fitted with one of the listed straight cams. Custom cylinder collars are available to accommodate cylinder lengths exceeding 1-1/8"

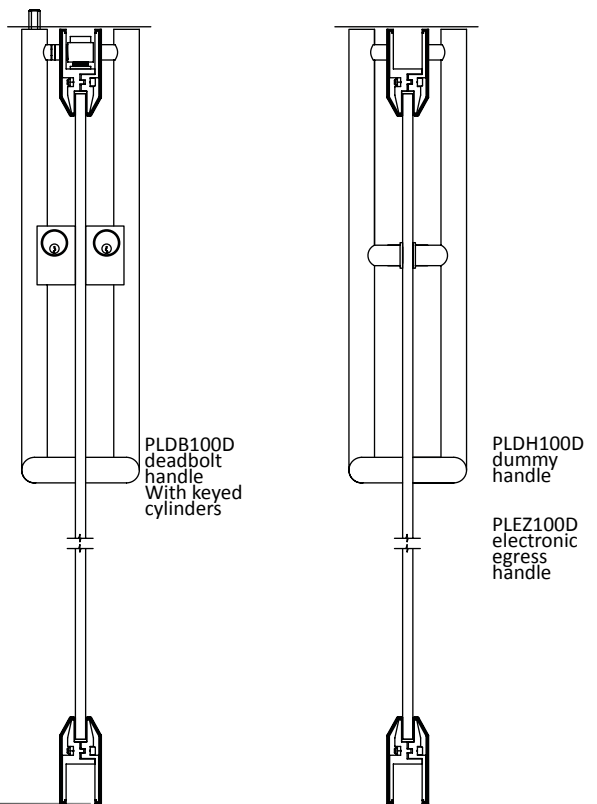
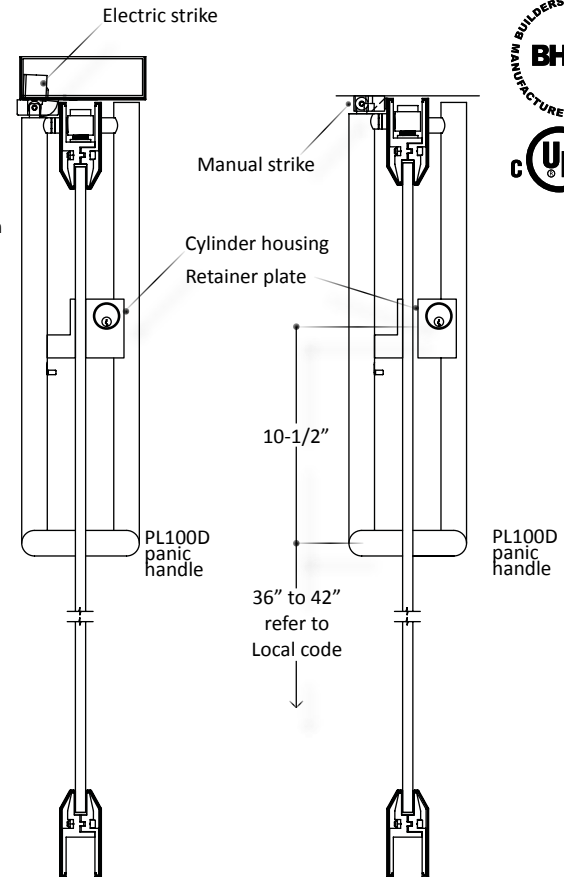



PL100F PANIC EXIT DEVICE

The operating system mechanism concealed within the vertical tubing retracts the latch bolt when the interior actuation bar is pushed. Optionally, an exterior keyed access device can be installed to allow entry. A dogging feature defeats locking action during business hours. Electronic strikes are available for use with our Panic Handles, providing many secured entry options.

PLDB100F DEADBOLT LOCK

The Deadbolt handle is offered with keyed cylinders on both the interior and exterior sides of the door, or with a thumb turn on the interior. An optional top latch bolt will permit the use of electronic strikes for controlled entry systems part # example = PLDBL100F see illustration

PLEZ100F ELECTRONIC EGRESS

The touch bar is an electronic exit device that does not require any special tools or knowledge to activate the lock. The simple act of touching the bar/handle (even through gloves or clothing) activates an electronic sensor which immediately releases the lock. No pressure is required for this use which provides superior egress safety for frail or disabled persons.

PLDH100F DUMMY HANDLE

These fixed handles are designed to match the appearance of Panic, Deadbolt, and Electronic Egress Handles, and are made from the same high quality materials.



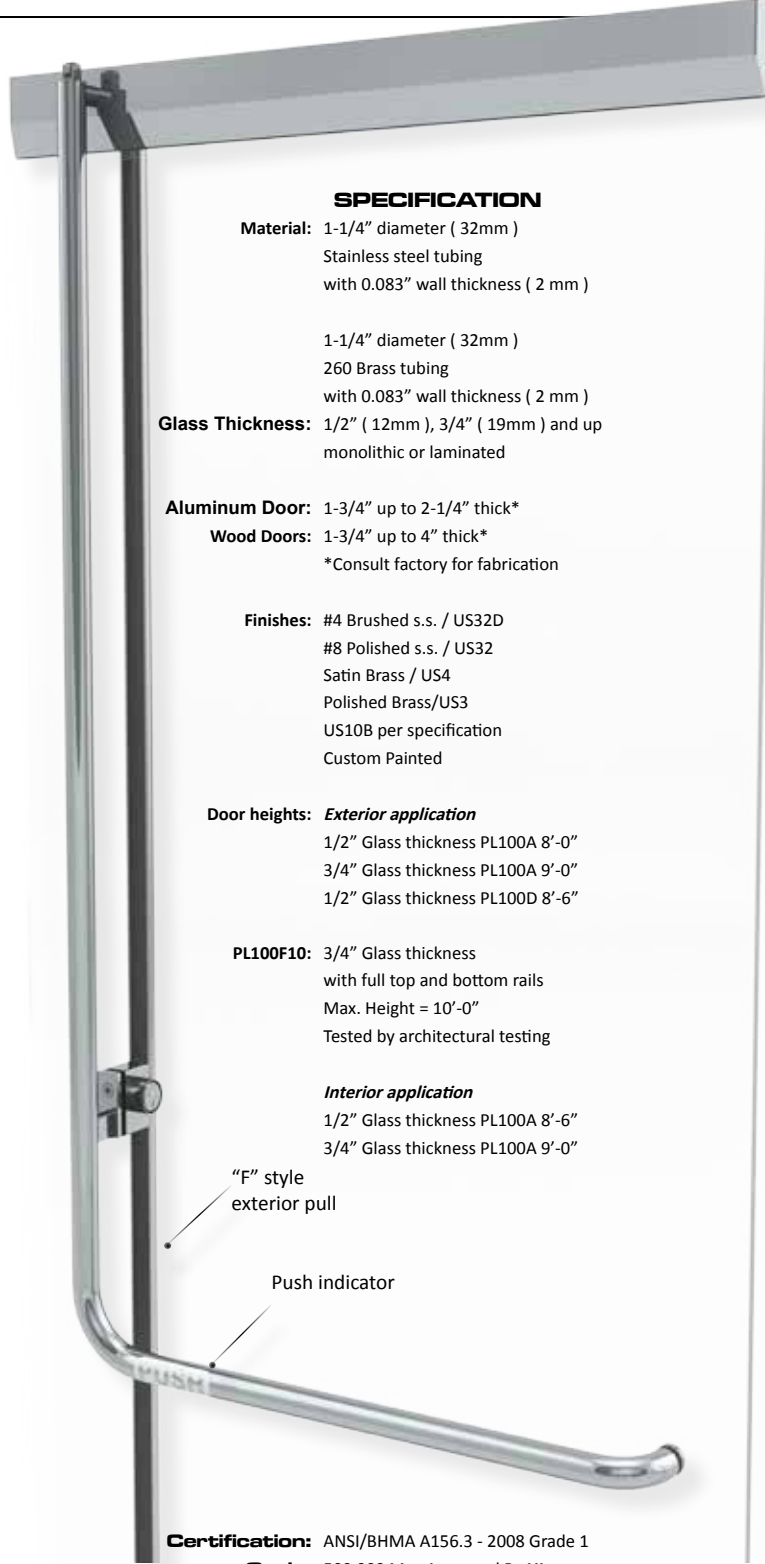

SPECIFICATION

Material: 1-1/4" diameter (32mm)
Stainless steel tubing
with 0.083" wall thickness (2 mm)

1-1/4" diameter (32mm)
260 Brass tubing
with 0.083" wall thickness (2 mm)

Glass Thickness: 1/2" (12mm), 3/4" (19mm) and up
monolithic or laminated

Aluminum Door: 1-3/4" up to 2-1/4" thick*

Wood Doors: 1-3/4" up to 4" thick*
*Consult factory for fabrication

Finishes: #4 Brushed s.s. / US32D
#8 Polished s.s. / US32
Satin Brass / US4
Polished Brass/US3
US10B per specification
Custom Painted

Door heights: Exterior application
1/2" Glass thickness PL100A 8'-0"
3/4" Glass thickness PL100A 9'-0"
1/2" Glass thickness PL100D 8'-6"

PL100F10: 3/4" Glass thickness
with full top and bottom rails
Max. Height = 10'-0"
Tested by architectural testing

Interior application
1/2" Glass thickness PL100A 8'-6"
3/4" Glass thickness PL100A 9'-0"

"F" style
exterior pull

Push indicator

Certification: ANSI/BHMA A156.3 - 2008 Grade 1
Cycle: 500,000 Max Approved By UL
1.3 million tested by Architectural testing

PL-100 Panics device and PLDB deadbolts
are all furnished with removable core
Custom collars are available to accommodate
cylinders with different lengths

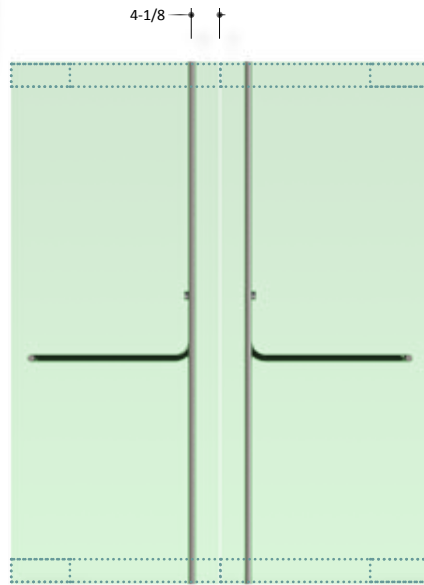

Exception

Maximum height for 1/2" glass doors is 108"
tall when using "F" style exterior handle

Increased sizes make the door assemblies heavier and more
flexible.

Therefore, the following guidelines should be considered:

- Wind load, stack action and ventilation loads
- Mounting conditions of doors to building structure
- Panic devices, Deadbolt locks or other hardware

- Overhead closer or floor closer characteristics
- Heavy usage and frequency of operation
- Comfortable feel and ease of door operation

The architect's structural engineer should be consulted to
assure that the door design is correct to the intended use

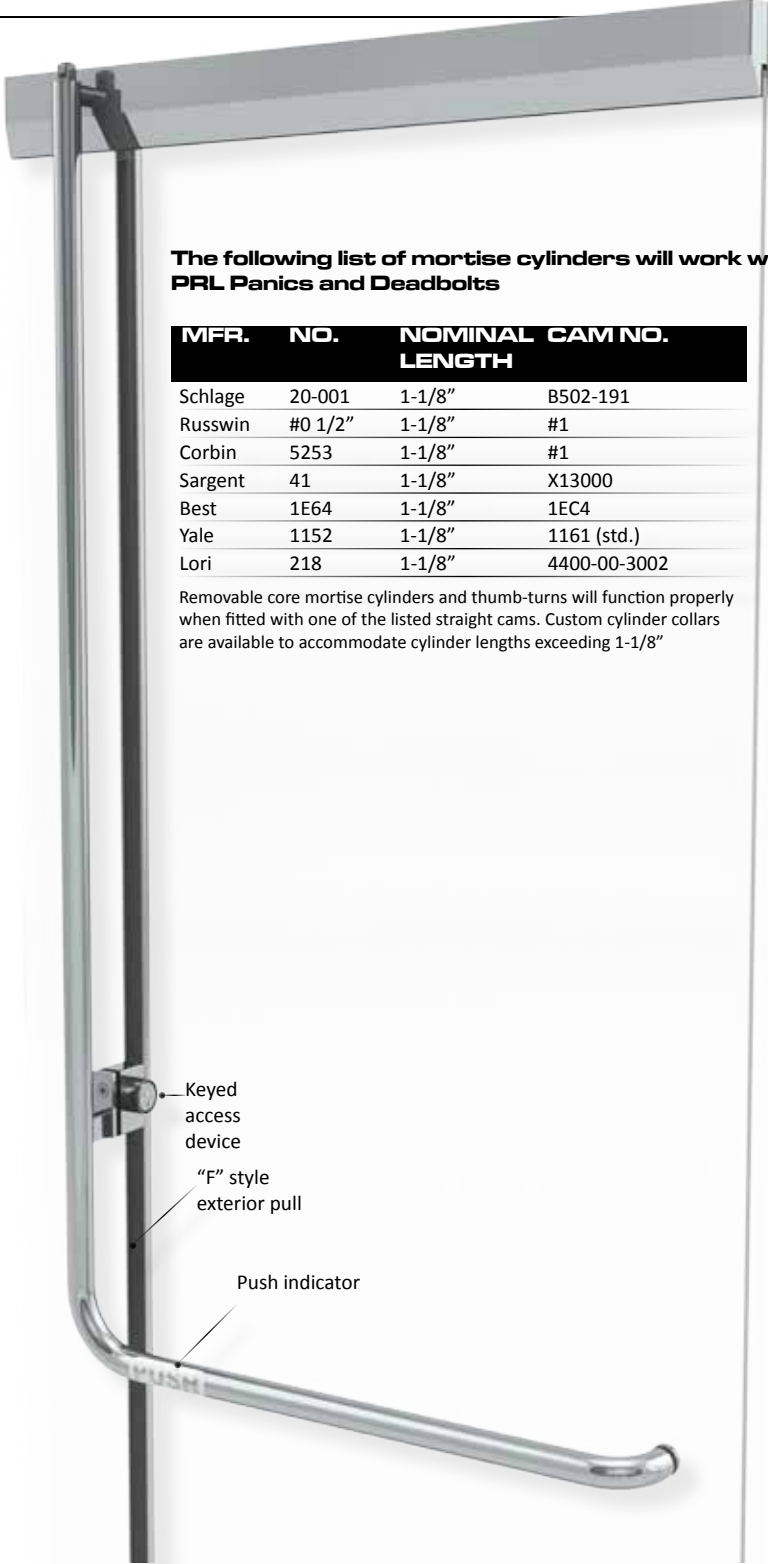

The following list of mortise cylinders will work with PRL Panics and Deadbolts

MFR.	NO.	NOMINAL CAM NO. LENGTH	
Schlage	20-001	1-1/8"	B502-191
Russwin	#0 1/2"	1-1/8"	#1
Corbin	5253	1-1/8"	#1
Sargent	41	1-1/8"	X13000
Best	1E64	1-1/8"	1EC4
Yale	1152	1-1/8"	1161 (std.)
Lori	218	1-1/8"	4400-00-3002

Removable core mortise cylinders and thumb-turns will function properly when fitted with one of the listed straight cams. Custom cylinder collars are available to accommodate cylinder lengths exceeding 1-1/8"

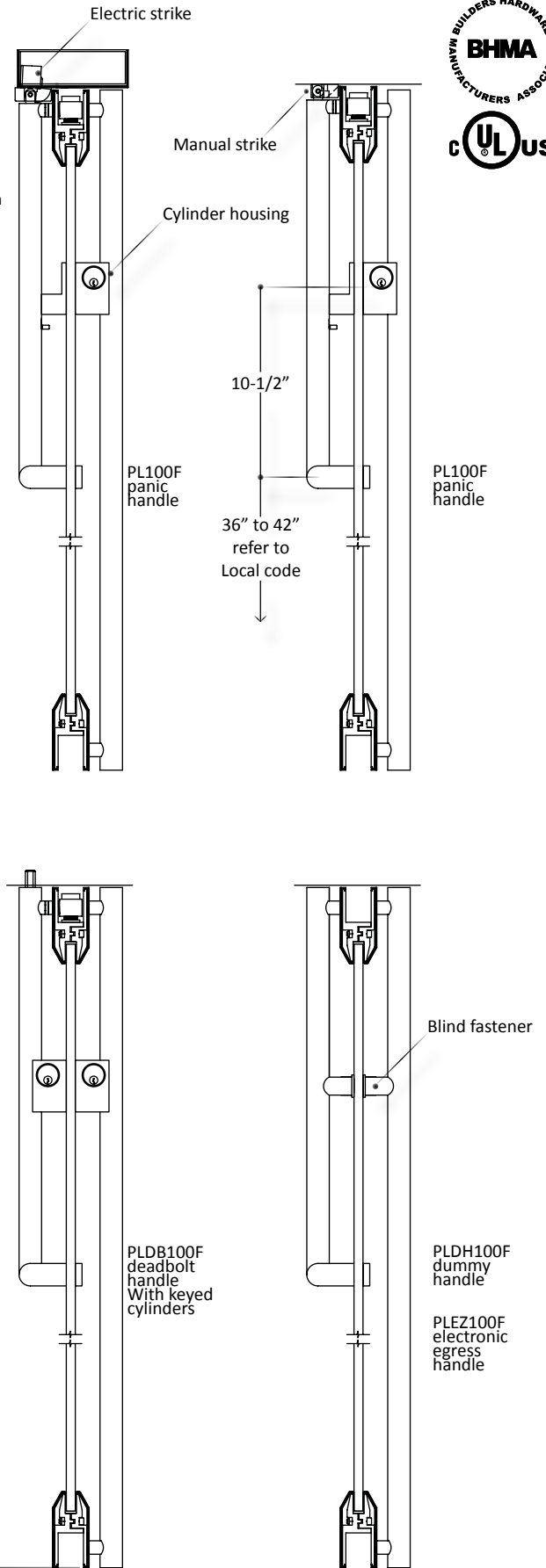

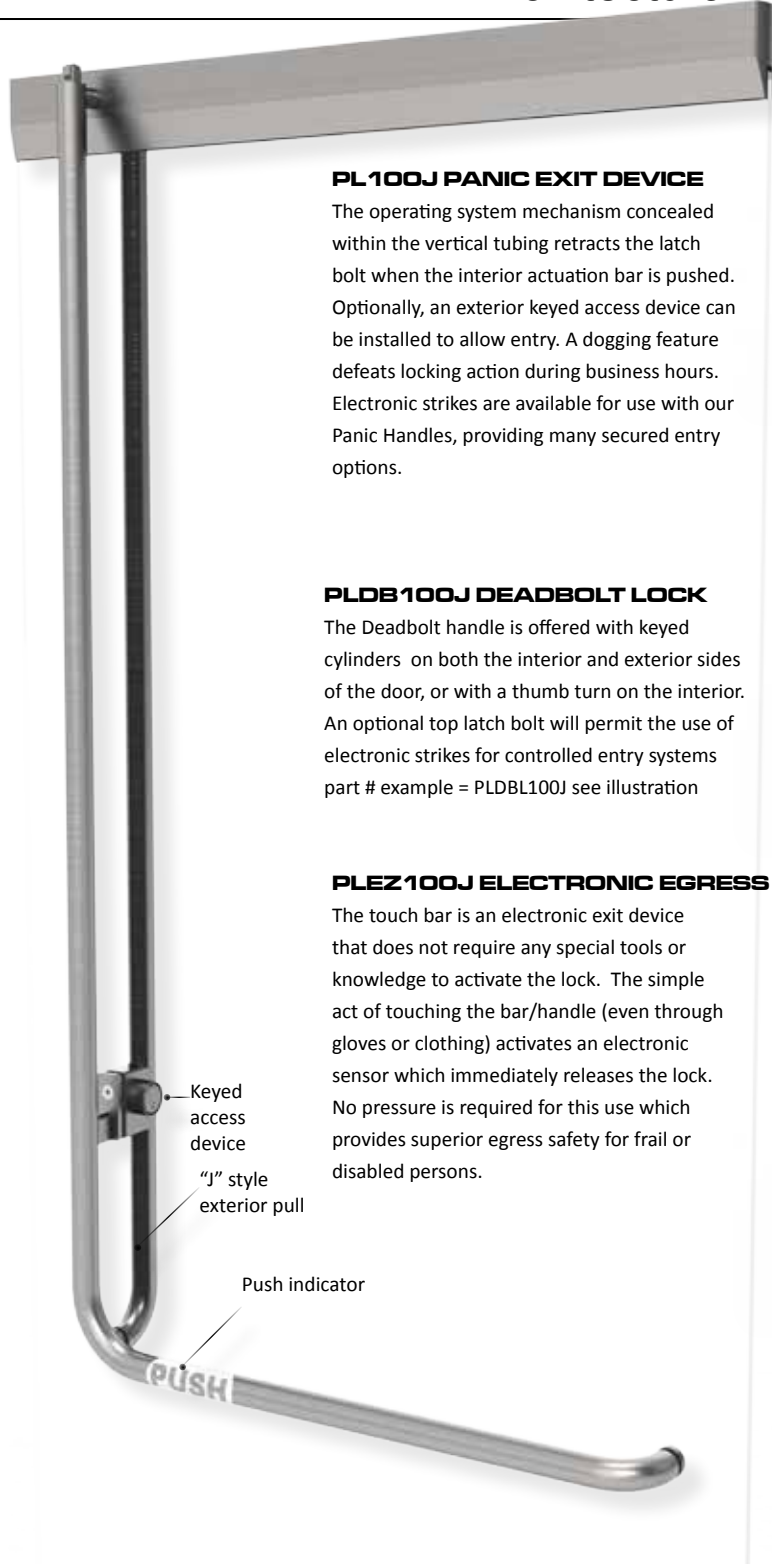

PL100J PANIC EXIT DEVICE

The operating system mechanism concealed within the vertical tubing retracts the latch bolt when the interior actuation bar is pushed. Optionally, an exterior keyed access device can be installed to allow entry. A dogging feature defeats locking action during business hours. Electronic strikes are available for use with our Panic Handles, providing many secured entry options.

PLDB100J DEADBOLT LOCK

The Deadbolt handle is offered with keyed cylinders on both the interior and exterior sides of the door, or with a thumb turn on the interior. An optional top latch bolt will permit the use of electronic strikes for controlled entry systems part # example = PLDBL100J see illustration

PLEZ100J ELECTRONIC EGRESS

The touch bar is an electronic exit device that does not require any special tools or knowledge to activate the lock. The simple act of touching the bar/handle (even through gloves or clothing) activates an electronic sensor which immediately releases the lock. No pressure is required for this use which provides superior egress safety for frail or disabled persons.

Keyed access device
"j" style exterior pull

Push indicator

PUSH

PLDH100A DUMMY HANDLE

These fixed handles are designed to match the appearance of Panic, Deadbolt, and Electronic Egress Handles, and are made from the same high quality materials.



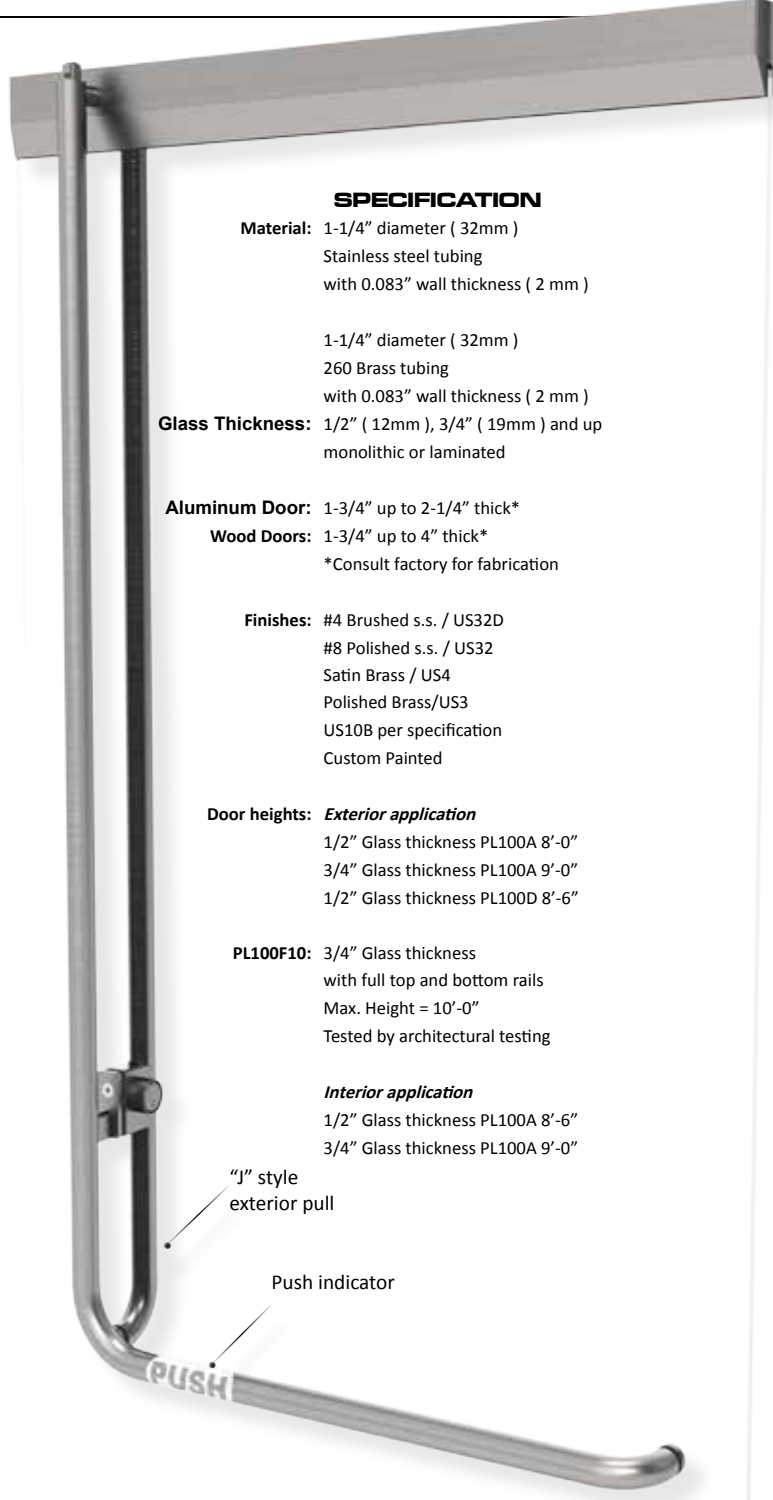

SPECIFICATION

Material: 1-1/4" diameter (32mm)
Stainless steel tubing
with 0.083" wall thickness (2 mm)

1-1/4" diameter (32mm)
260 Brass tubing
with 0.083" wall thickness (2 mm)

Glass Thickness: 1/2" (12mm), 3/4" (19mm) and up
monolithic or laminated

Aluminum Door: 1-3/4" up to 2-1/4" thick*

Wood Doors: 1-3/4" up to 4" thick*
*Consult factory for fabrication

Finishes: #4 Brushed s.s. / US32D
#8 Polished s.s. / US32
Satin Brass / US4
Polished Brass/US3
US10B per specification
Custom Painted

Door heights: Exterior application
1/2" Glass thickness PL100A 8'-0"
3/4" Glass thickness PL100A 9'-0"
1/2" Glass thickness PL100D 8'-6"

PL100F10: 3/4" Glass thickness
with full top and bottom rails
Max. Height = 10'-0"
Tested by architectural testing

Interior application
1/2" Glass thickness PL100A 8'-6"
3/4" Glass thickness PL100A 9'-0"

"J" style
exterior pull

Push indicator

Certification: ANSI/BHMA A156.3 - 2008 Grade 1
Cycle: 500,000 Max Approved By UL
1.3 million tested by Architectural testing

PL-100 Panics device and PLDB deadbolts
are all furnished with removable core
Custom collars are available to accommodate
cylinders with different lengths

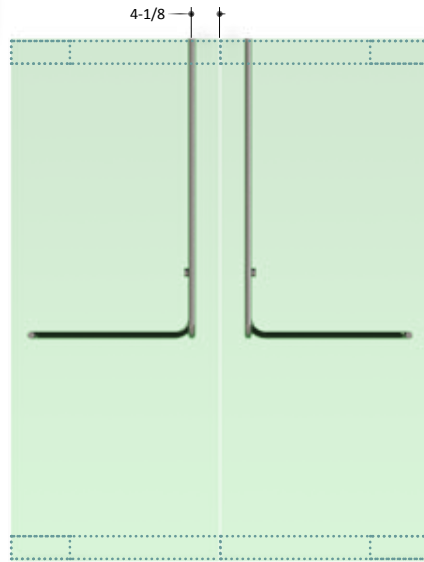

Exception

Maximum height for 1/2' glass doors is 108"
tall when using "F" style exterior handle

Increased sizes make the door assemblies heavier and more
flexible.

Therefore, the following guidelines should be considered:

- Wind load, stack action and ventilation loads
- Mounting conditions of doors to building structure
- Panic devices, Deadbolt locks or other hardware

- Overhead closer or floor closer characteristics
- Heavy usage and frequency of operation
- Comfortable feel and ease of door operation

The architect's structural engineer should be consulted to
assure that the door design is correct to the intended use

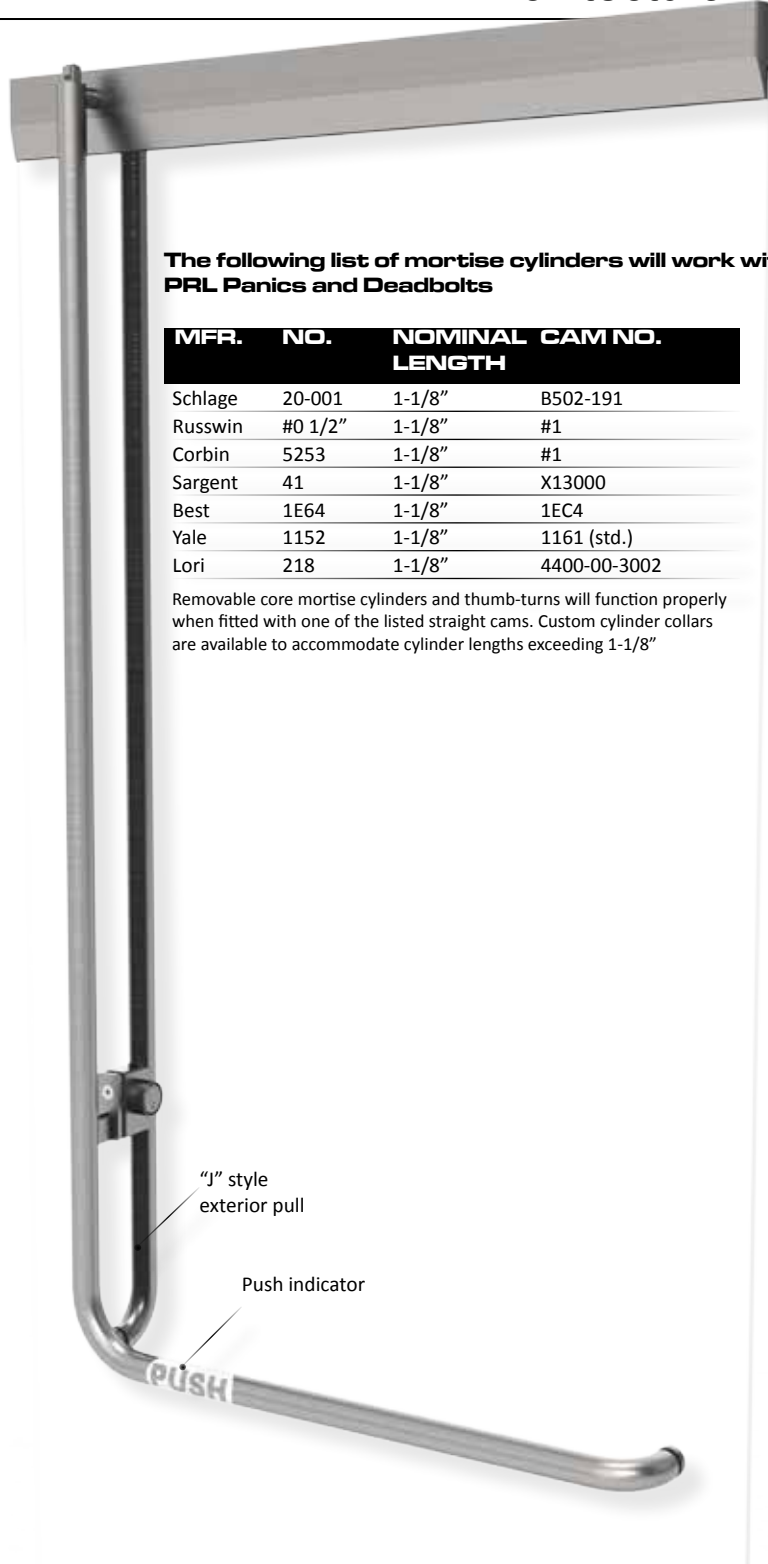

The following list of mortise cylinders will work with PRL Panics and Deadbolts

MFR.	NO.	NOMINAL LENGTH	CAM NO.
Schlage	20-001	1-1/8"	B502-191
Russwin	#0 1/2"	1-1/8"	#1
Corbin	5253	1-1/8"	#1
Sargent	41	1-1/8"	X13000
Best	1E64	1-1/8"	1EC4
Yale	1152	1-1/8"	1161 (std.)
Lori	218	1-1/8"	4400-00-3002

Removable core mortise cylinders and thumb-turns will function properly when fitted with one of the listed straight cams. Custom cylinder collars are available to accommodate cylinder lengths exceeding 1-1/8"

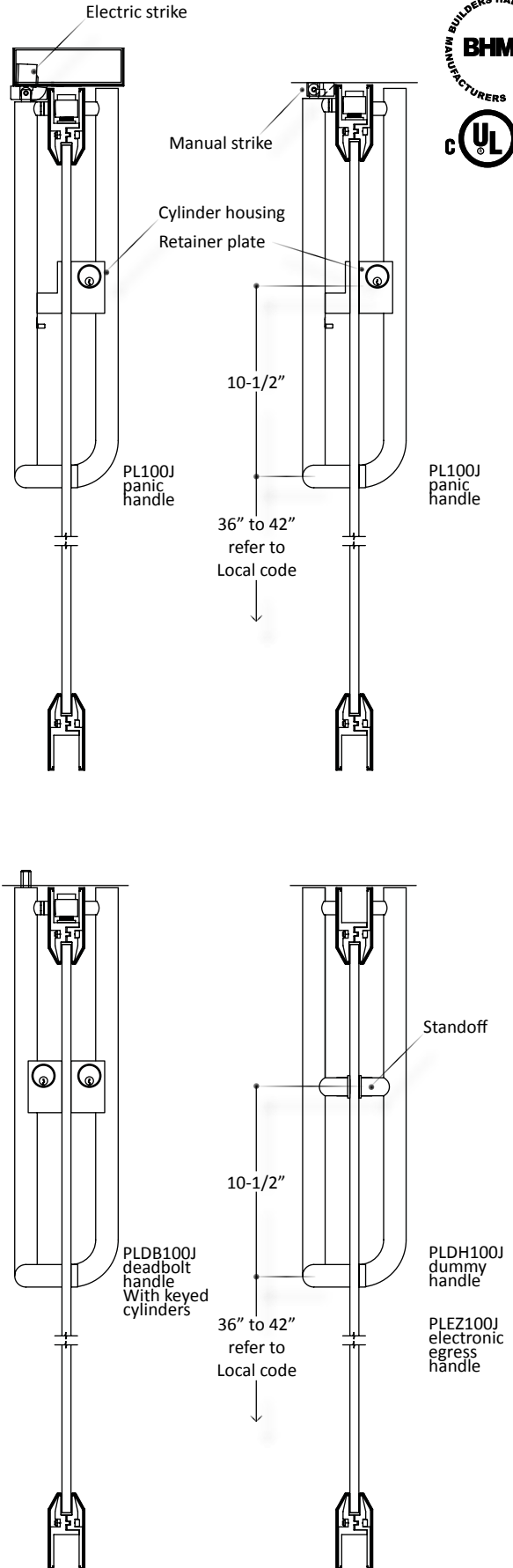

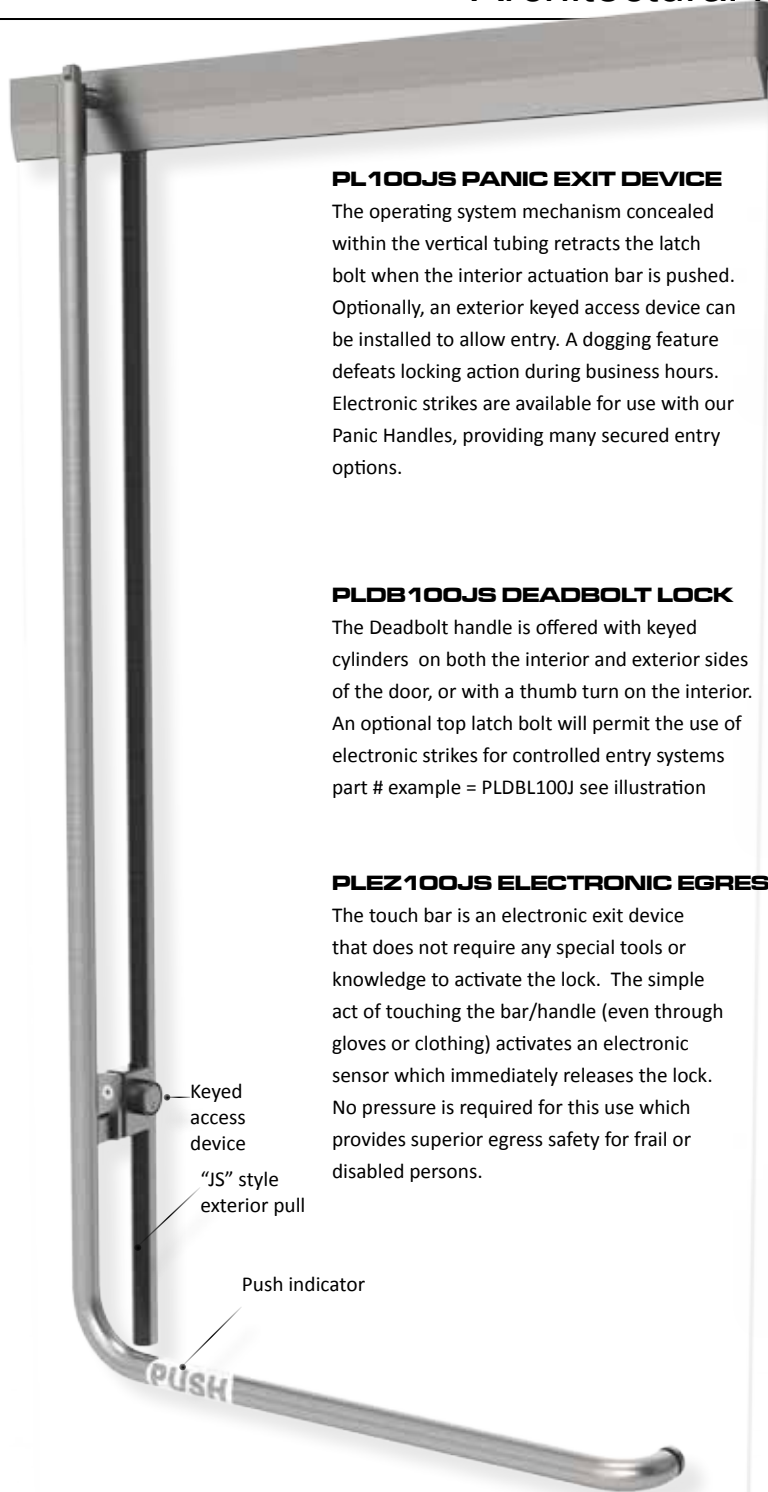

PL100JS PANIC EXIT DEVICE

The operating system mechanism concealed within the vertical tubing retracts the latch bolt when the interior actuation bar is pushed. Optionally, an exterior keyed access device can be installed to allow entry. A dogging feature defeats locking action during business hours. Electronic strikes are available for use with our Panic Handles, providing many secured entry options.

PLDB100JS DEADBOLT LOCK

The Deadbolt handle is offered with keyed cylinders on both the interior and exterior sides of the door, or with a thumb turn on the interior. An optional top latch bolt will permit the use of electronic strikes for controlled entry systems part # example = PLDBL100J see illustration

PLEZ100JS ELECTRONIC EGRESS

The touch bar is an electronic exit device that does not require any special tools or knowledge to activate the lock. The simple act of touching the bar/handle (even through gloves or clothing) activates an electronic sensor which immediately releases the lock. No pressure is required for this use which provides superior egress safety for frail or disabled persons.

PLDH100JS DUMMY HANDLE

These fixed handles are designed to match the appearance of Panic, Deadbolt, and Electronic Egress Handles, and are made from the same high quality materials.



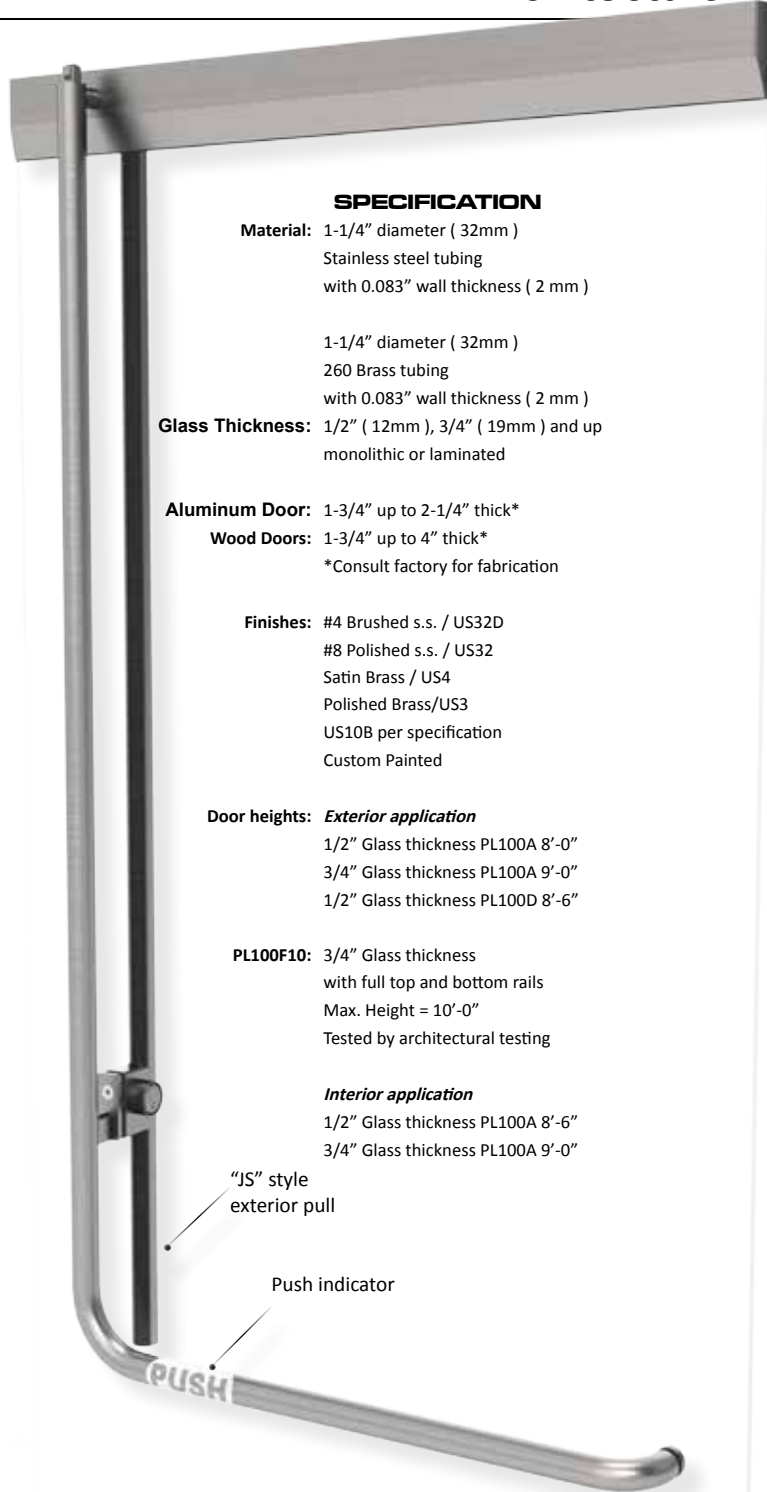

SPECIFICATION

Material: 1-1/4" diameter (32mm)
Stainless steel tubing
with 0.083" wall thickness (2 mm)

1-1/4" diameter (32mm)
260 Brass tubing
with 0.083" wall thickness (2 mm)

Glass Thickness: 1/2" (12mm), 3/4" (19mm) and up
monolithic or laminated

Aluminum Door: 1-3/4" up to 2-1/4" thick*

Wood Doors: 1-3/4" up to 4" thick*
*Consult factory for fabrication

Finishes: #4 Brushed s.s. / US32D
#8 Polished s.s. / US32
Satin Brass / US4
Polished Brass/US3
US10B per specification
Custom Painted

Door heights: Exterior application
1/2" Glass thickness PL100A 8'-0"
3/4" Glass thickness PL100A 9'-0"
1/2" Glass thickness PL100D 8'-6"

PL100F10: 3/4" Glass thickness
with full top and bottom rails
Max. Height = 10'-0"
Tested by architectural testing

Interior application
1/2" Glass thickness PL100A 8'-6"
3/4" Glass thickness PL100A 9'-0"

"JS" style
exterior pull

Push indicator

Certification: ANSI/BHMA A156.3 - 2008 Grade 1
Cycle: 500,000 Max Approved By UL
1.3 million tested by Architectural testing

PL-100 Panics device and PLDB deadbolts
are all furnished with removable core
Custom collars are available to accommodate
cylinders with different lengths

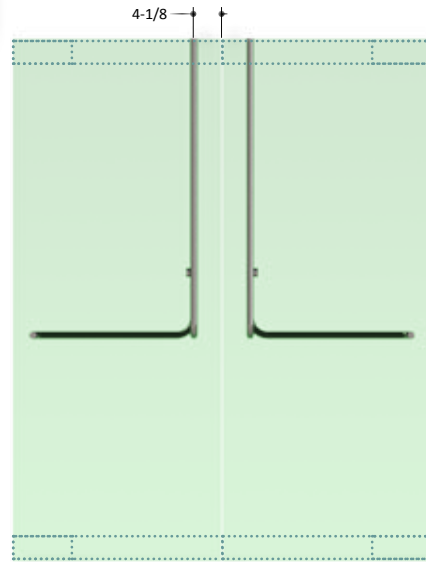

Exception

Maximum height for 1/2' glass doors is 108"
tall when using "F" style exterior handle

Increased sizes make the door assemblies heavier and more
flexible.

Therefore, the following guidelines should be considered:

- Wind load, stack action and ventilation loads
- Mounting conditions of doors to building structure
- Panic devices, Deadbolt locks or other hardware
- Overhead closer or floor closer characteristics
- Heavy usage and frequency of operation
- Comfortable feel and ease of door operation

The architect's structural engineer should be consulted to
assure that the door design is correct to the intended use



The following list of mortise cylinders will work with PRL Panics and Deadbolts

MFR.	NO.	NOMINAL LENGTH	CAM NO.
Schlage	20-001	1-1/8"	B502-191
Russwin	#0 1/2"	1-1/8"	#1
Corbin	5253	1-1/8"	#1
Sargent	41	1-1/8"	X13000
Best	1E64	1-1/8"	1EC4
Yale	1152	1-1/8"	1161 (std.)
Lori	218	1-1/8"	4400-00-3002

Removable core mortise cylinders and thumb-turns will function properly when fitted with one of the listed straight cams. Custom cylinder collars are available to accommodate cylinder lengths exceeding 1-1/8"

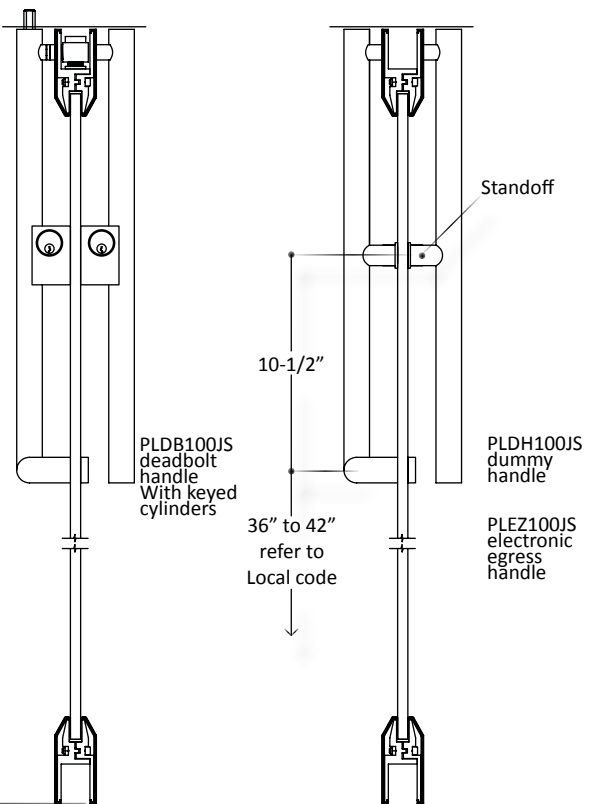
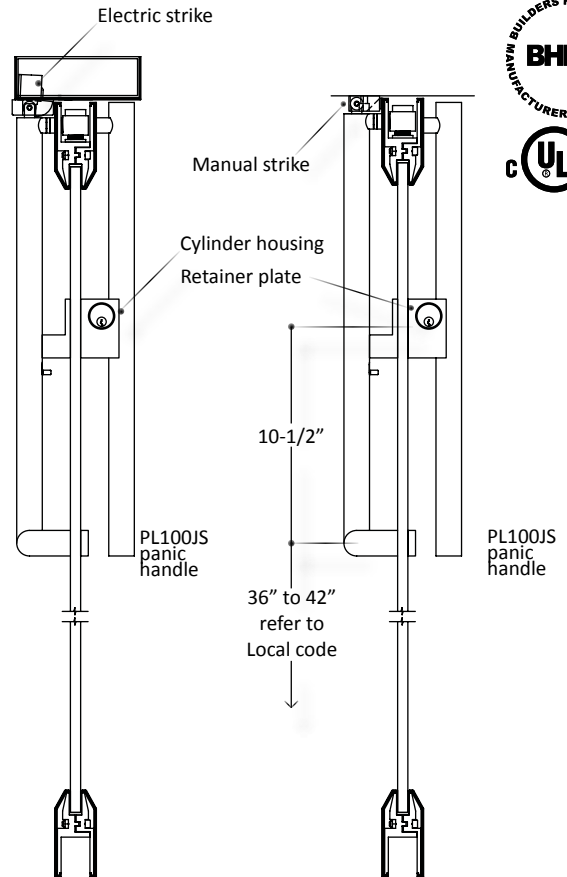

PRL GLASS SYSTEMS

PL100 PANIC HANDLE CONFIGURATIONS

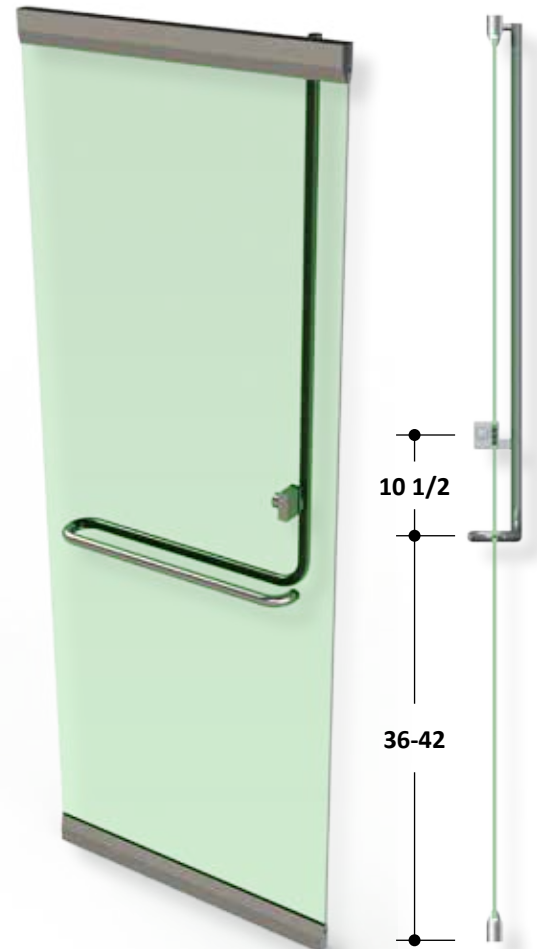
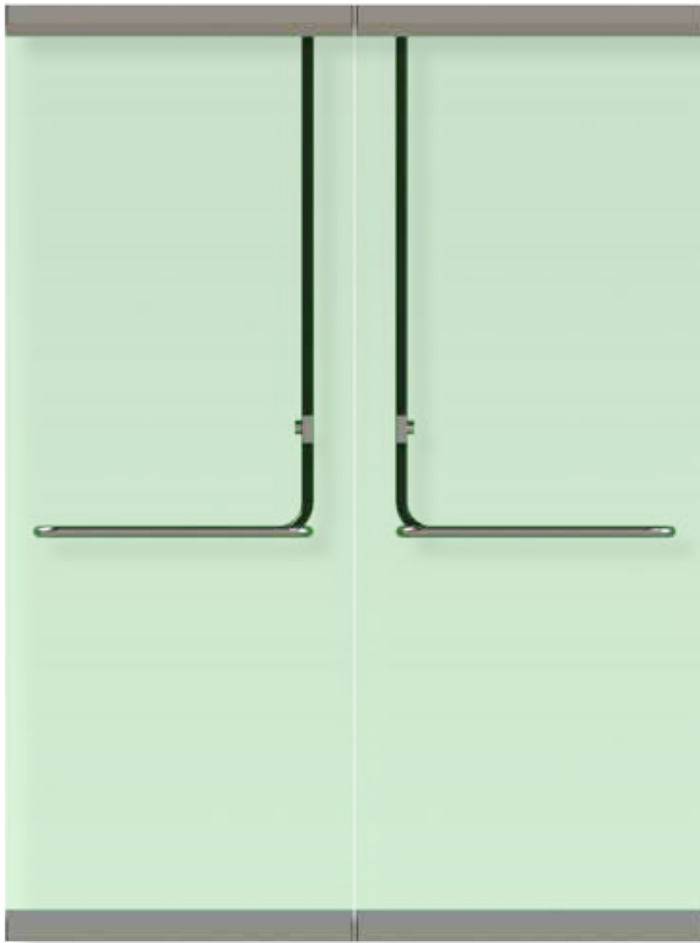

PL100A

Finish

- #4 brushed stainless steel
- #8 polished stainless steel
- Satin brass
- Polished brass
- us10b
- Custom painted

The following list of mortise cylinders will work with PRL Panics and Deadbolts

MFR.	NO.	NOMINAL LENGTH	CAM NO.
Schlage	20-001	1-1/8"	B502-191
Russwin	#0 1/2"	1-1/8"	#1
Corbin	5253	1-1/8"	#1
Sargent	41	1-1/8"	X13000
Best	1E64	1-1/8"	1EC4
Yale	1152	1-1/8"	1161 (std.)
Lori	218	1-1/8"	4400-00-3002

Removable core mortise cylinders and thumb-turns will function properly when fitted with one of the listed straight cams. Custom cylinder collars are available to accommodate cylinder lengths exceeding 1-1/8"

PRL GLASS SYSTEMS

PL100 PANIC HANDLE CONFIGURATIONS

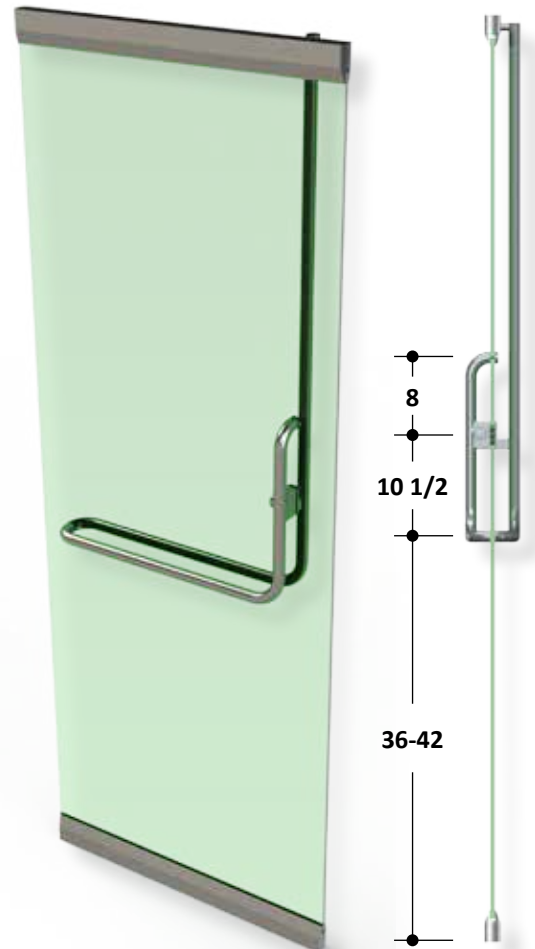
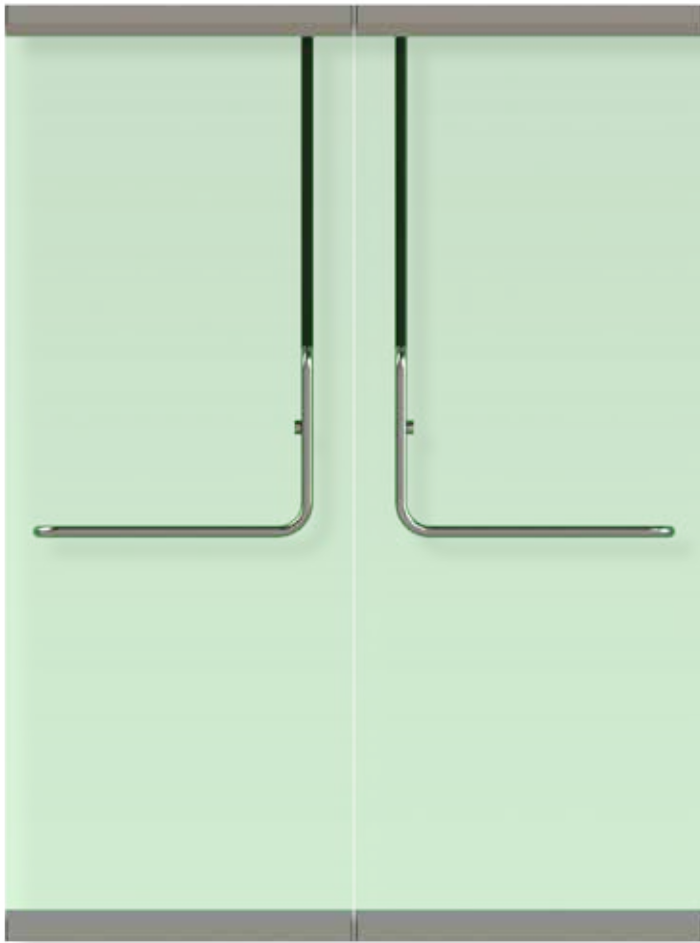

PL100B

Finish

- #4 brushed stainless steel
- #8 polished stainless steel
- Satin brass
- Polished brass
- us10b
- Custom painted

The following list of mortise cylinders will work with PRL Panics and Deadbolts

MFR.	NO.	NOMINAL LENGTH	CAM NO.
Schlage	20-001	1-1/8"	B502-191
Russwin	#0 1/2"	1-1/8"	#1
Corbin	5253	1-1/8"	#1
Sargent	41	1-1/8"	X13000
Best	1E64	1-1/8"	1EC4
Yale	1152	1-1/8"	1161 (std.)
Lori	218	1-1/8"	4400-00-3002

Removable core mortise cylinders and thumb-turns will function properly when fitted with one of the listed straight cams. Custom cylinder collars are available to accommodate cylinder lengths exceeding 1-1/8"

PRL GLASS SYSTEMS

PL100 PANIC HANDLE CONFIGURATIONS

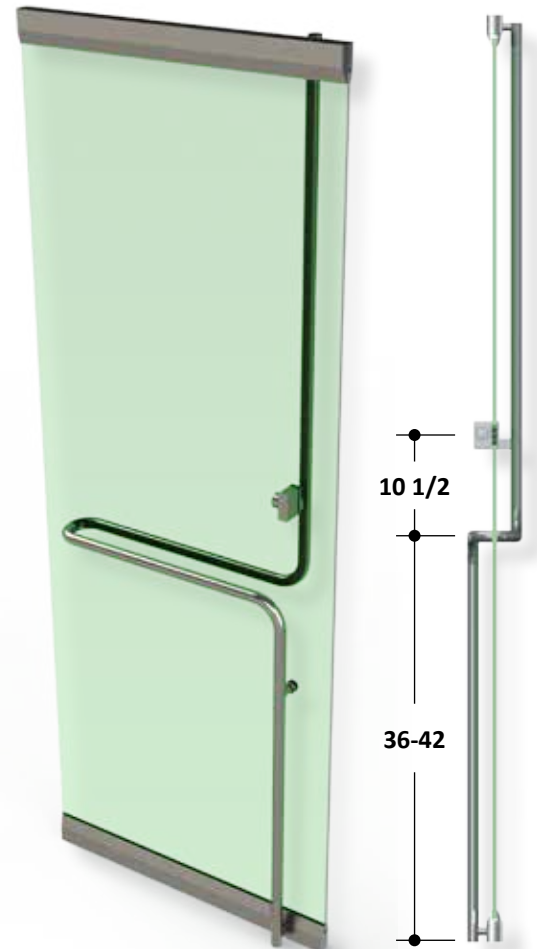
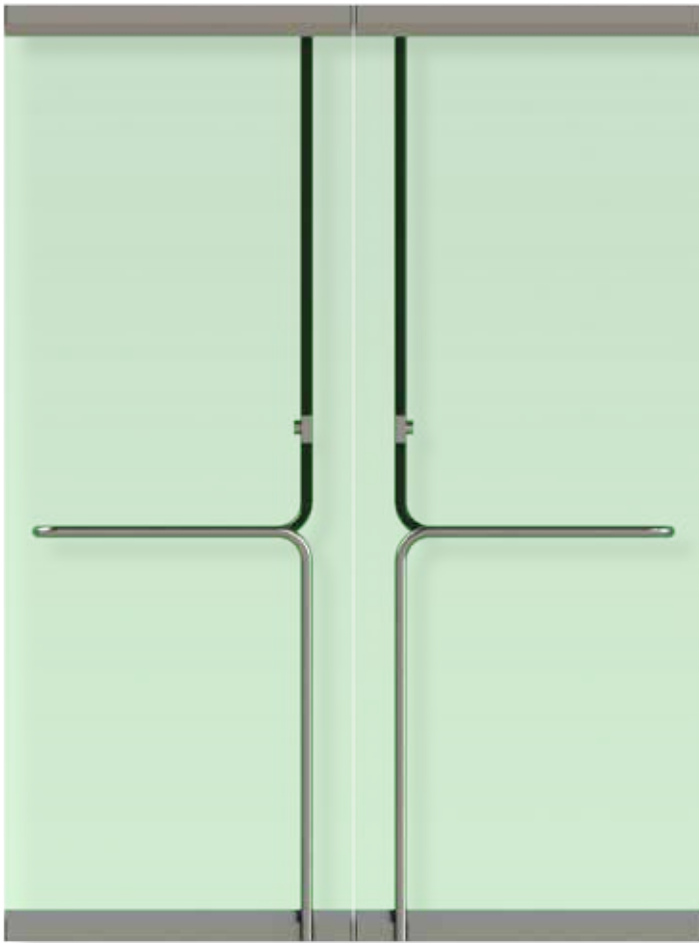

PL100C

Finish

- #4 brushed stainless steel
- #8 polished stainless steel
- Satin brass
- Polished brass
- us10b
- Custom painted

The following list of mortise cylinders will work with PRL Panics and Deadbolts

MFR.	NO.	NOMINAL LENGTH	CAM NO.
Schlage	20-001	1-1/8"	B502-191
Russwin	#0 1/2"	1-1/8"	#1
Corbin	5253	1-1/8"	#1
Sargent	41	1-1/8"	X13000
Best	1E64	1-1/8"	1EC4
Yale	1152	1-1/8"	1161 (std.)
Lori	218	1-1/8"	4400-00-3002

Removable core mortise cylinders and thumb-turns will function properly when fitted with one of the listed straight cams. Custom cylinder collars are available to accommodate cylinder lengths exceeding 1-1/8"

PRL GLASS SYSTEMS

PL100 PANIC HANDLE CONFIGURATIONS

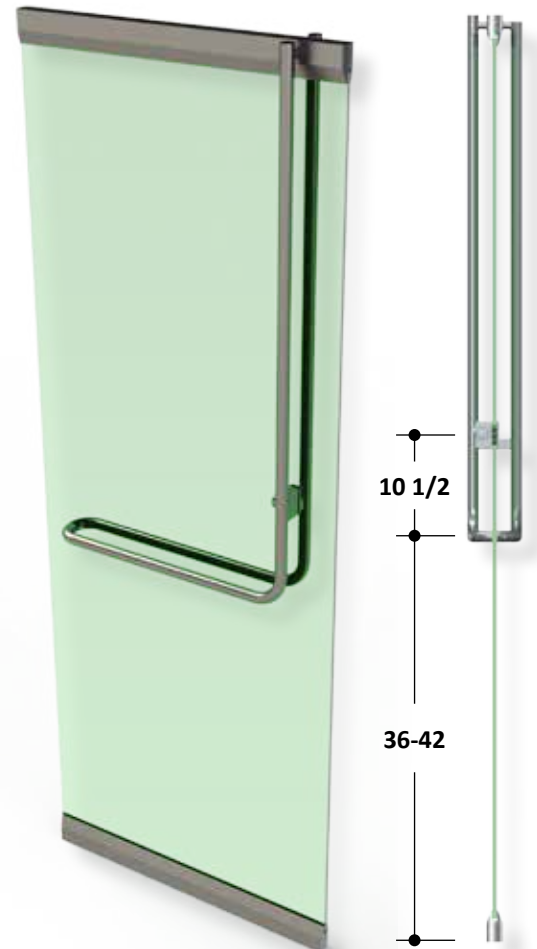
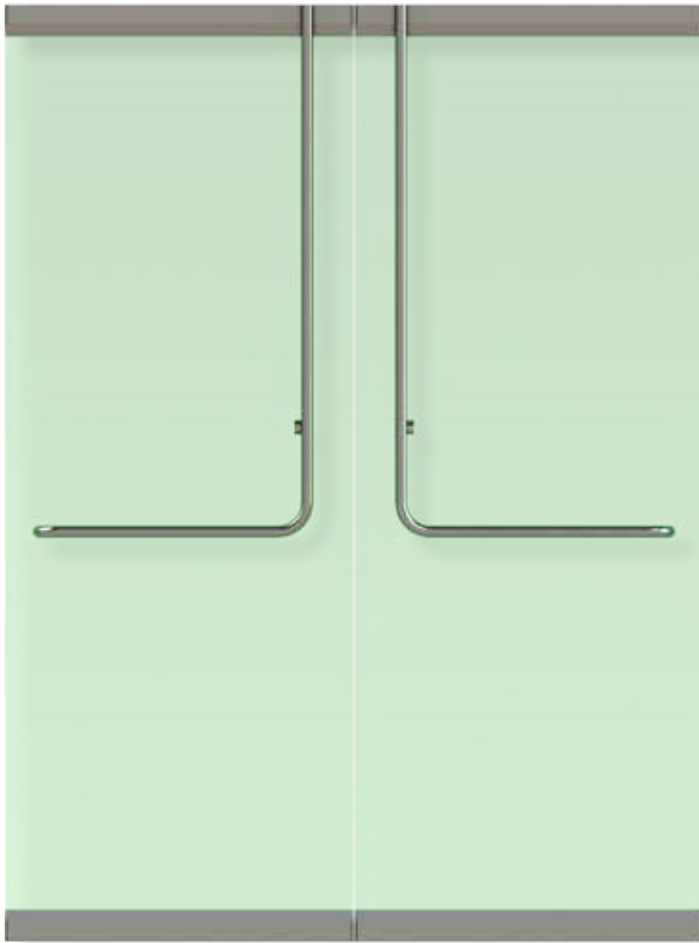

PL100D

Finish

- #4 brushed stainless steel
- #8 polished stainless steel
- Satin brass
- Polished brass
- us10b
- Custom painted

The following list of mortise cylinders will work with PRL Panics and Deadbolts

MFR.	NO.	NOMINAL LENGTH	CAM NO.
Schlage	20-001	1-1/8"	B502-191
Russwin	#0 1/2"	1-1/8"	#1
Corbin	5253	1-1/8"	#1
Sargent	41	1-1/8"	X13000
Best	1E64	1-1/8"	1EC4
Yale	1152	1-1/8"	1161 (std.)
Lori	218	1-1/8"	4400-00-3002

Removable core mortise cylinders and thumb-turns will function properly when fitted with one of the listed straight cams. Custom cylinder collars are available to accommodate cylinder lengths exceeding 1-1/8"

PRL GLASS SYSTEMS

PL100 PANIC HANDLE CONFIGURATIONS

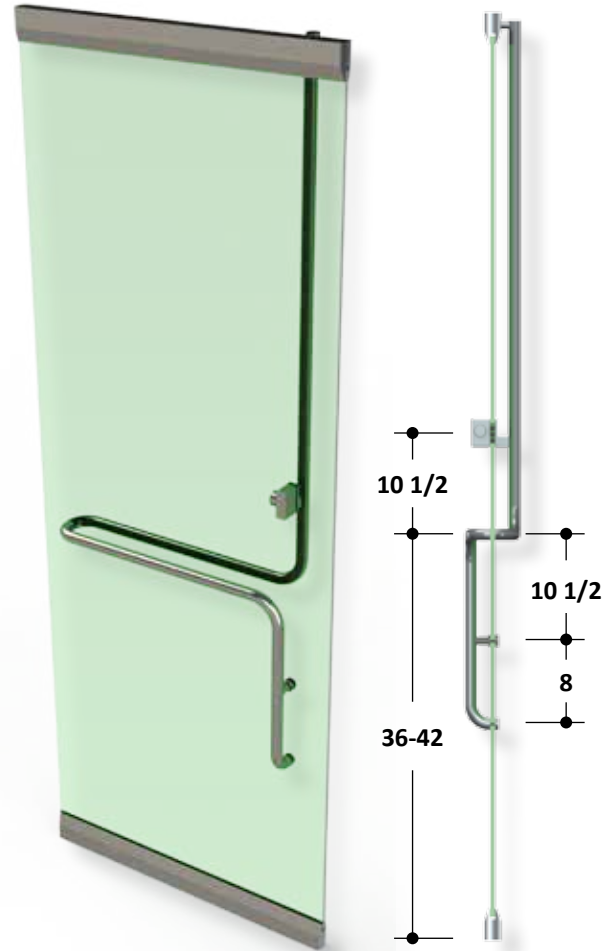
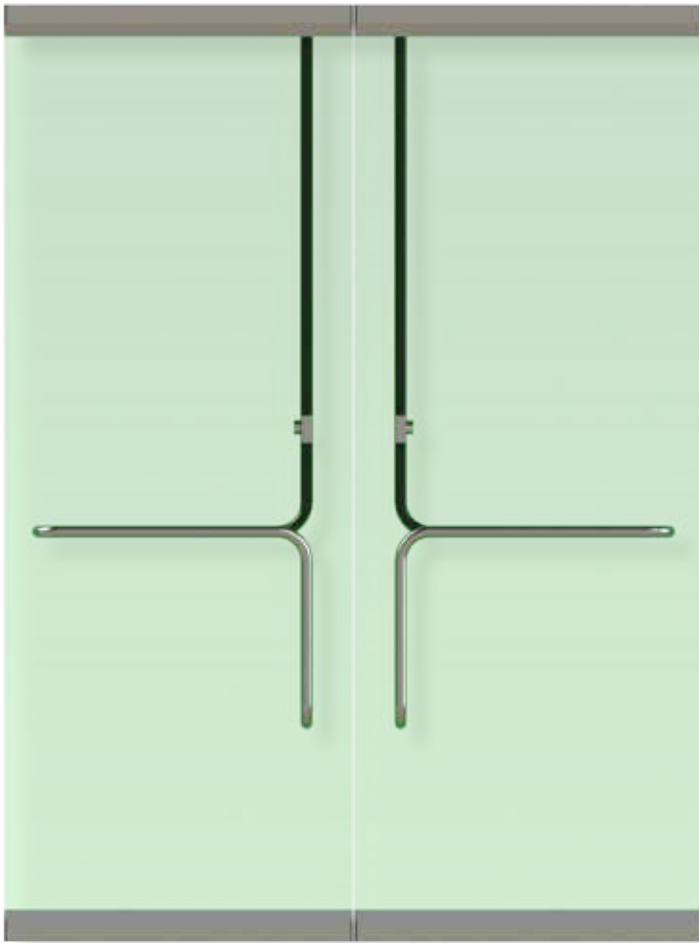

PL100E

Finish

- #4 brushed stainless steel
- #8 polished stainless steel
- Satin brass
- Polished brass
- us10b
- Custom painted

The following list of mortise cylinders will work with PRL Panics and Deadbolts

MFR.	NO.	NOMINAL LENGTH	CAM NO.
Schlage	20-001	1-1/8"	B502-191
Russwin	#0 1/2"	1-1/8"	#1
Corbin	5253	1-1/8"	#1
Sargent	41	1-1/8"	X13000
Best	1E64	1-1/8"	1EC4
Yale	1152	1-1/8"	1161 (std.)
Lori	218	1-1/8"	4400-00-3002

Removable core mortise cylinders and thumb-turns will function properly when fitted with one of the listed straight cams. Custom cylinder collars are available to accommodate cylinder lengths exceeding 1-1/8"

PRL GLASS SYSTEMS

PL100 PANIC HANDLE CONFIGURATIONS

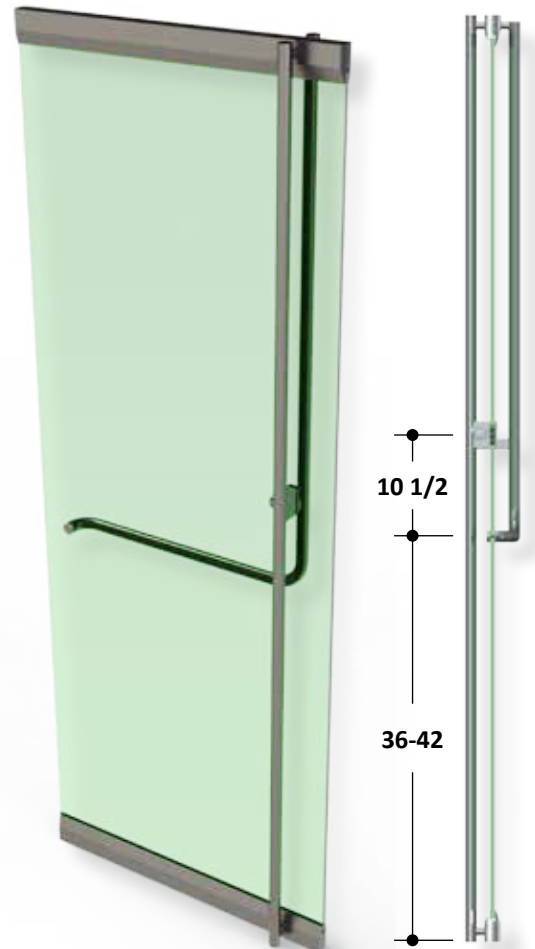
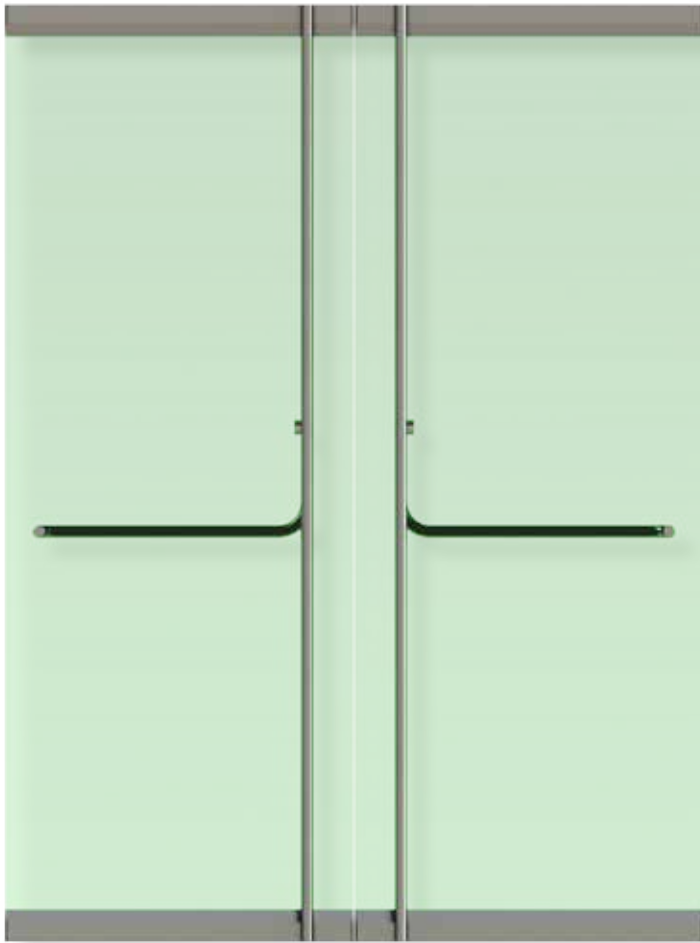

PL100F

Finish

- #4 brushed stainless steel
- #8 polished stainless steel
- Satin brass
- Polished brass
- us10b
- Custom painted

The following list of mortise cylinders will work with PRL Panics and Deadbolts

MFR.	NO.	NOMINAL LENGTH	CAM NO.
Schlage	20-001	1-1/8"	B502-191
Russwin	#0 1/2"	1-1/8"	#1
Corbin	5253	1-1/8"	#1
Sargent	41	1-1/8"	X13000
Best	1E64	1-1/8"	1EC4
Yale	1152	1-1/8"	1161 (std.)
Lori	218	1-1/8"	4400-00-3002

Removable core mortise cylinders and thumb-turns will function properly when fitted with one of the listed straight cams. Custom cylinder collars are available to accommodate cylinder lengths exceeding 1-1/8"

PRL GLASS SYSTEMS

PL100 PANIC HANDLE CONFIGURATIONS

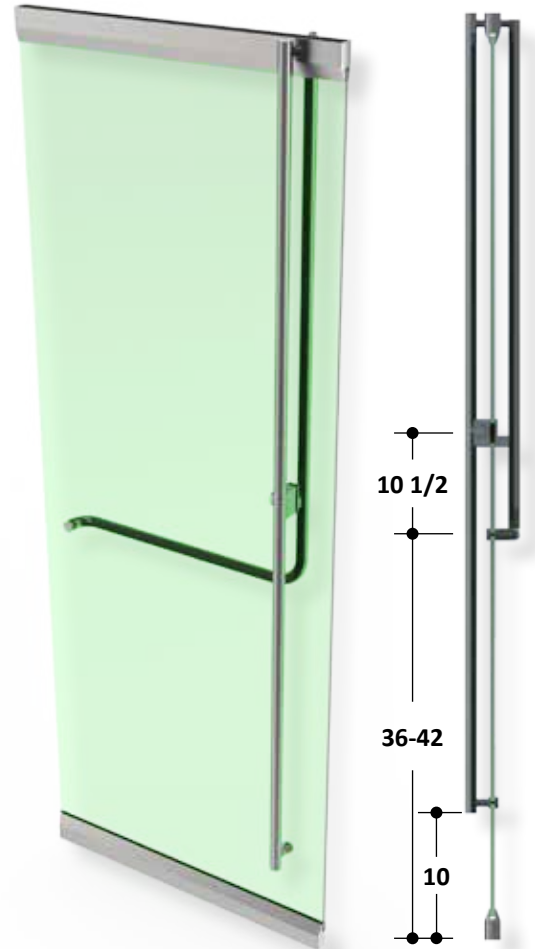
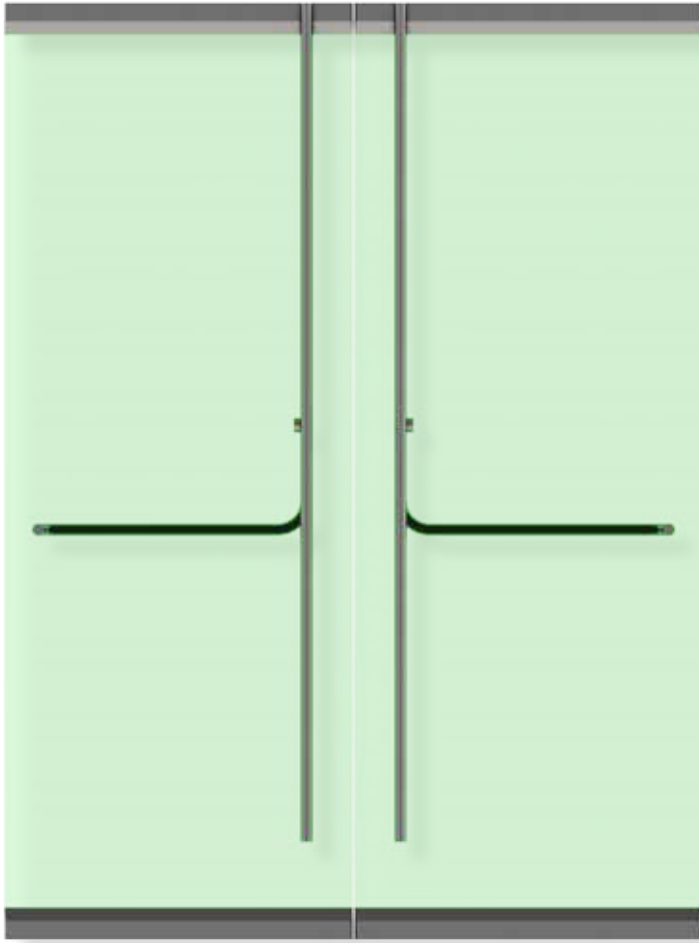

PL100FADA

Finish

- #4 brushed stainless steel
- #8 polished stainless steel
- Satin brass
- Polished brass
- us10b
- Custom painted

The PL100FADA panic handle is designed to meet ADA compliance. The exterior handle measures 10" from bottom of door to bottom of exterior handle.

The following list of mortise cylinders will work with PRL Panics and Deadbolts

MFR.	NO.	NOMINAL LENGTH	CAM NO.
Schlage	20-001	1-1/8"	B502-191
Russwin	#0 1/2"	1-1/8"	#1
Corbin	5253	1-1/8"	#1
Sargent	41	1-1/8"	X13000
Best	1E64	1-1/8"	1EC4
Yale	1152	1-1/8"	1161 (std.)
Lori	218	1-1/8"	4400-00-3002

Removable core mortise cylinders and thumb-turns will function properly when fitted with one of the listed straight cams. Custom cylinder collars are available to accommodate cylinder lengths exceeding 1-1/8"

PRL GLASS SYSTEMS

PL100 PANIC HANDLE CONFIGURATIONS

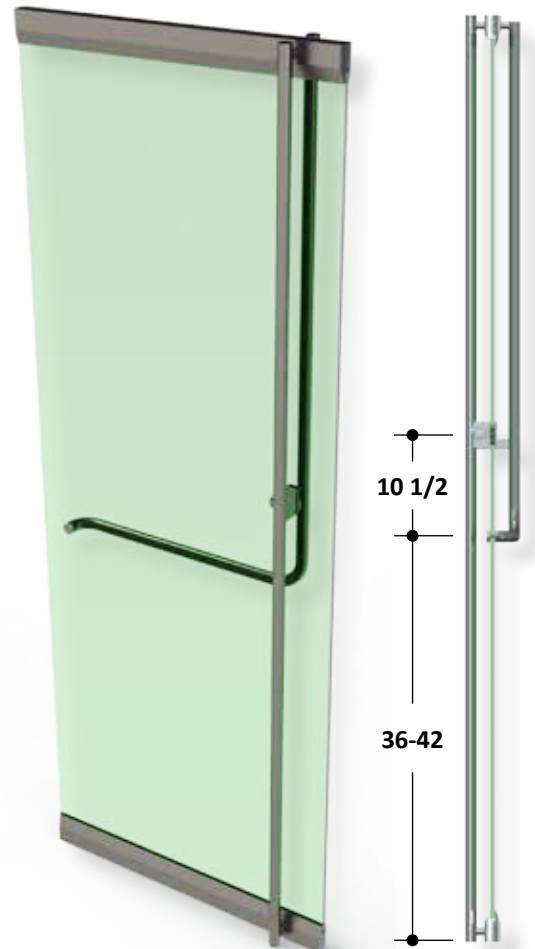
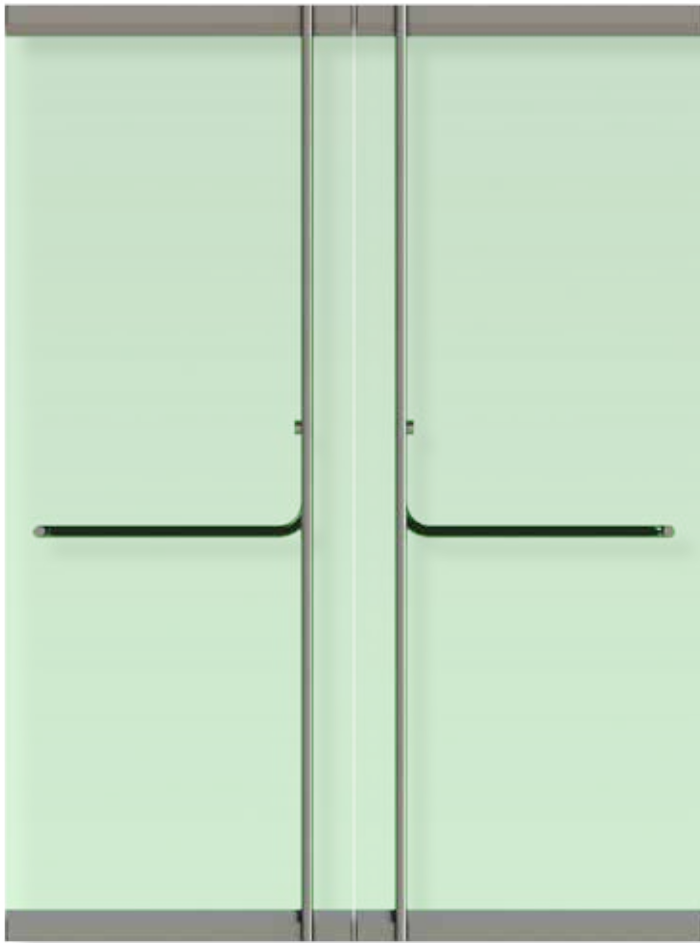

PL100F10

Finish

- #4 brushed stainless steel
- #8 polished stainless steel
- Satin brass
- Polished brass
- us10b
- Custom painted

The PL100F10 is a heavy duty panic handle designed for over sized doors up to 120" tall by using 3/4" tempered glass and a full height "F" exterior handle UL Approved and tested by Architectural testing

The following list of mortise cylinders will work with PRL Panics and Deadbolts

MFR.	NO.	NOMINAL LENGTH	CAM NO.
Schlage	20-001	1-1/8"	B502-191
Russwin	#0 1/2"	1-1/8"	#1
Corbin	5253	1-1/8"	#1
Sargent	41	1-1/8"	X13000
Best	1E64	1-1/8"	1EC4
Yale	1152	1-1/8"	1161 (std.)
Lori	218	1-1/8"	4400-00-3002

Removable core mortise cylinders and thumb-turns will function properly when fitted with one of the listed straight cams. Custom cylinder collars are available to accommodate cylinder lengths exceeding 1-1/8"

PRL GLASS SYSTEMS

PL100 PANIC HANDLE CONFIGURATIONS

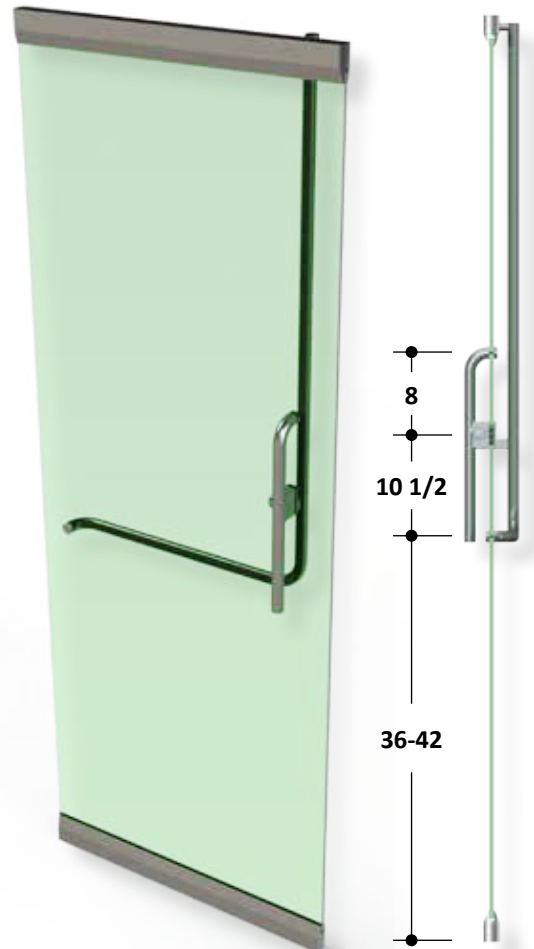
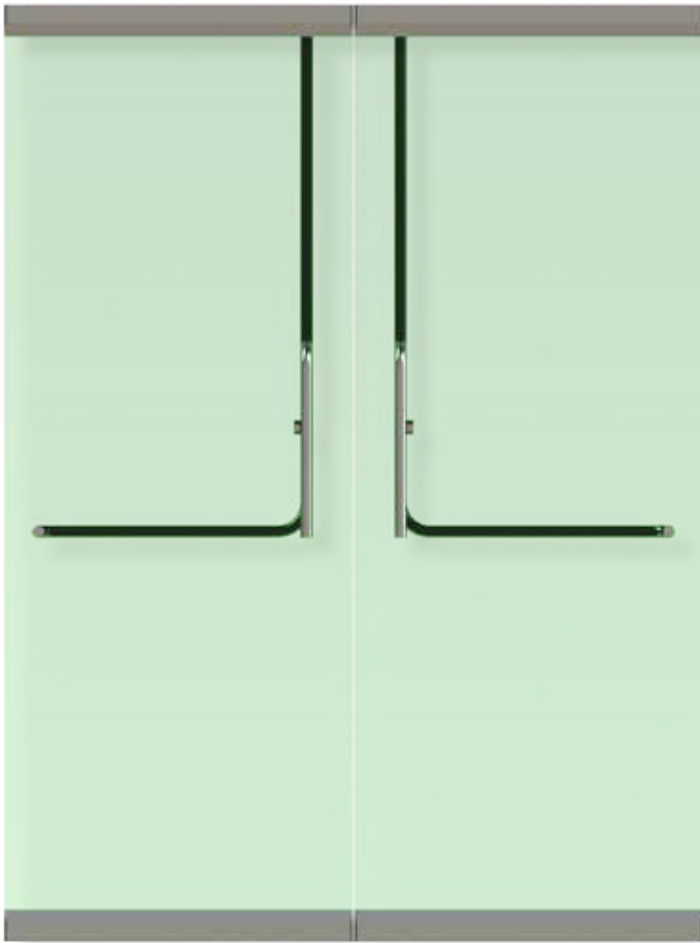

PL100G

Finish

- #4 brushed stainless steel
- #8 polished stainless steel
- Satin brass
- Polished brass
- us10b
- Custom painted

The following list of mortise cylinders will work with PRL Panics and Deadbolts

MFR.	NO.	NOMINAL LENGTH	CAM NO.
Schlage	20-001	1-1/8"	B502-191
Russwin	#0 1/2"	1-1/8"	#1
Corbin	5253	1-1/8"	#1
Sargent	41	1-1/8"	X13000
Best	1E64	1-1/8"	1EC4
Yale	1152	1-1/8"	1161 (std.)
Lori	218	1-1/8"	4400-00-3002

Removable core mortise cylinders and thumb-turns will function properly when fitted with one of the listed straight cams. Custom cylinder collars are available to accommodate cylinder lengths exceeding 1-1/8"

PRL GLASS SYSTEMS

PL100 PANIC HANDLE CONFIGURATIONS

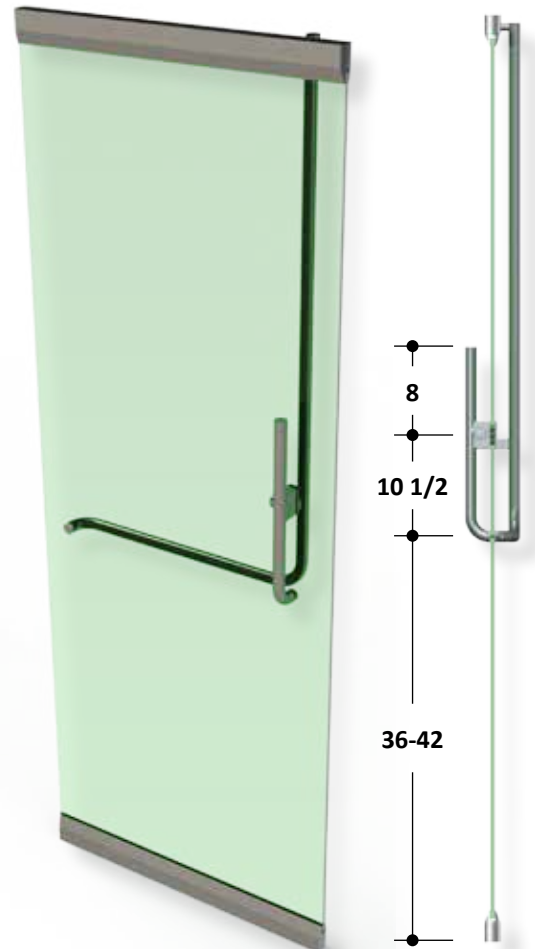
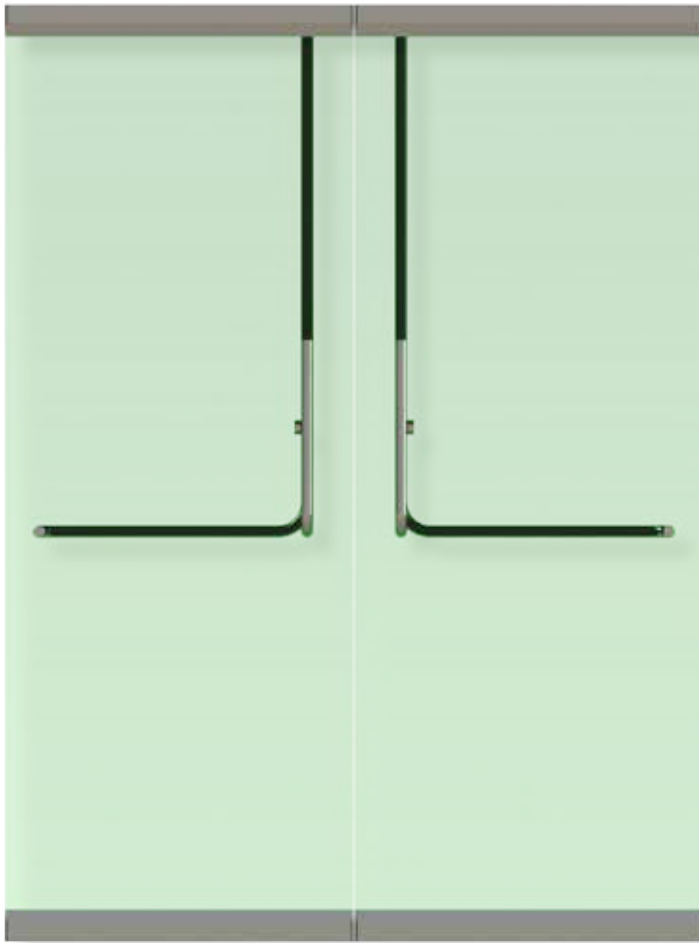

PL100H

Finish

- #4 brushed stainless steel
- #8 polished stainless steel
- Satin brass
- Polished brass
- us10b
- Custom painted

The following list of mortise cylinders will work with PRL Panics and Deadbolts

MFR.	NO.	NOMINAL LENGTH	CAM NO.
Schlage	20-001	1-1/8"	B502-191
Russwin	#0 1/2"	1-1/8"	#1
Corbin	5253	1-1/8"	#1
Sargent	41	1-1/8"	X13000
Best	1E64	1-1/8"	1EC4
Yale	1152	1-1/8"	1161 (std.)
Lori	218	1-1/8"	4400-00-3002

Removable core mortise cylinders and thumb-turns will function properly when fitted with one of the listed straight cams. Custom cylinder collars are available to accommodate cylinder lengths exceeding 1-1/8"

PRL GLASS SYSTEMS

PL100 PANIC HANDLE CONFIGURATIONS

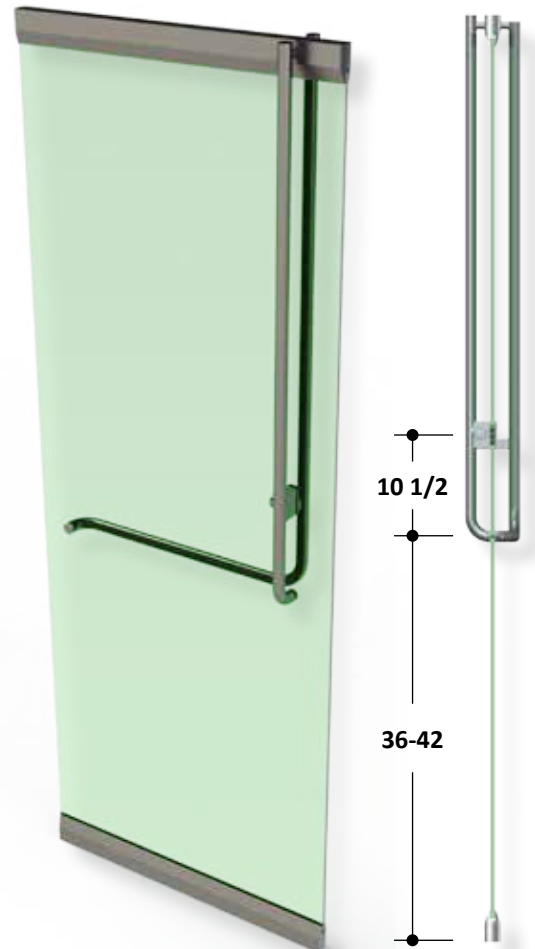
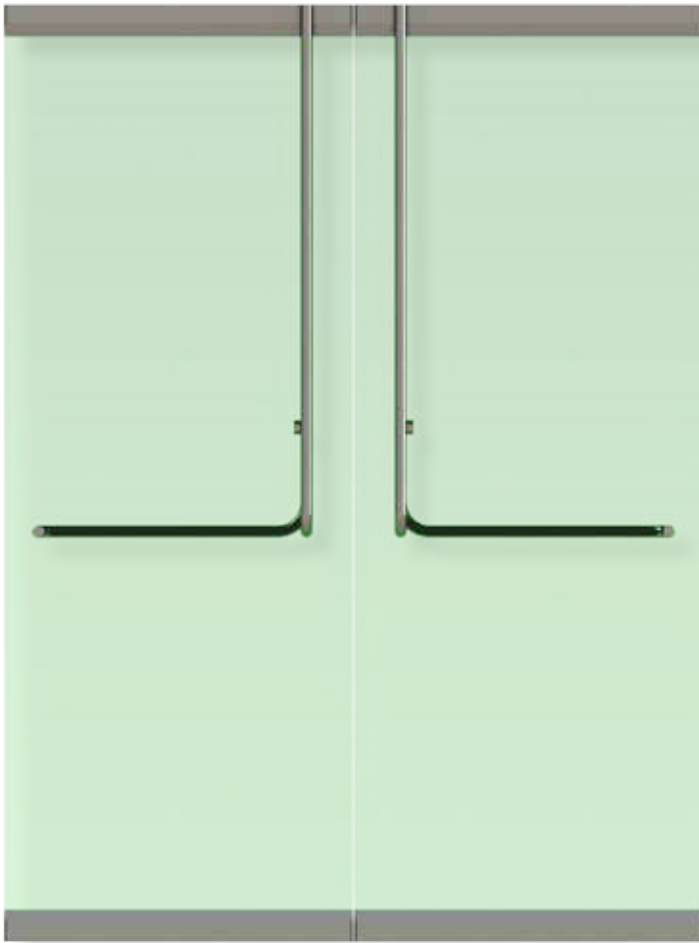

PL100J

Finish

- #4 brushed stainless steel
- #8 polished stainless steel
- Satin brass
- Polished brass
- us10b
- Custom painted

The following list of mortise cylinders will work with PRL Panics and Deadbolts

MFR.	NO.	NOMINAL LENGTH	CAM NO.
Schlage	20-001	1-1/8"	B502-191
Russwin	#0 1/2"	1-1/8"	#1
Corbin	5253	1-1/8"	#1
Sargent	41	1-1/8"	X13000
Best	1E64	1-1/8"	1EC4
Yale	1152	1-1/8"	1161 (std.)
Lori	218	1-1/8"	4400-00-3002

Removable core mortise cylinders and thumb-turns will function properly when fitted with one of the listed straight cams. Custom cylinder collars are available to accommodate cylinder lengths exceeding 1-1/8"

PRL GLASS SYSTEMS

PL100 PANIC HANDLE CONFIGURATIONS

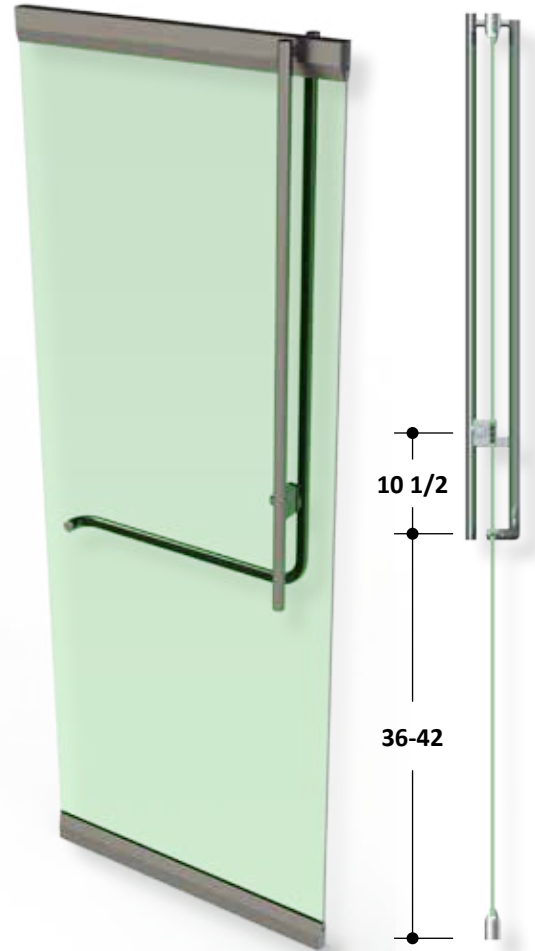
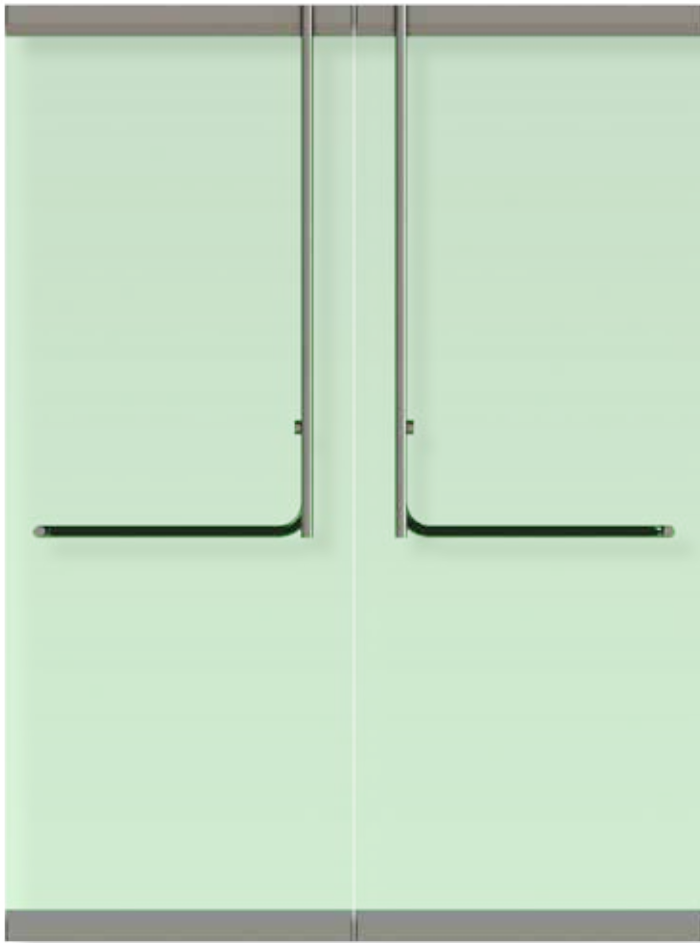

PL100JS

Finish

- #4 brushed stainless steel
- #8 polished stainless steel
- Satin brass
- Polished brass
- us10b
- Custom painted

The following list of mortise cylinders will work with PRL Panics and Deadbolts

MFR.	NO.	NOMINAL LENGTH	CAM NO.
Schlage	20-001	1-1/8"	B502-191
Russwin	#0 1/2"	1-1/8"	#1
Corbin	5253	1-1/8"	#1
Sargent	41	1-1/8"	X13000
Best	1E64	1-1/8"	1EC4
Yale	1152	1-1/8"	1161 (std.)
Lori	218	1-1/8"	4400-00-3002

Removable core mortise cylinders and thumb-turns will function properly when fitted with one of the listed straight cams. Custom cylinder collars are available to accommodate cylinder lengths exceeding 1-1/8"

PRL GLASS SYSTEMS

PL100 PANIC HANDLE CONFIGURATIONS

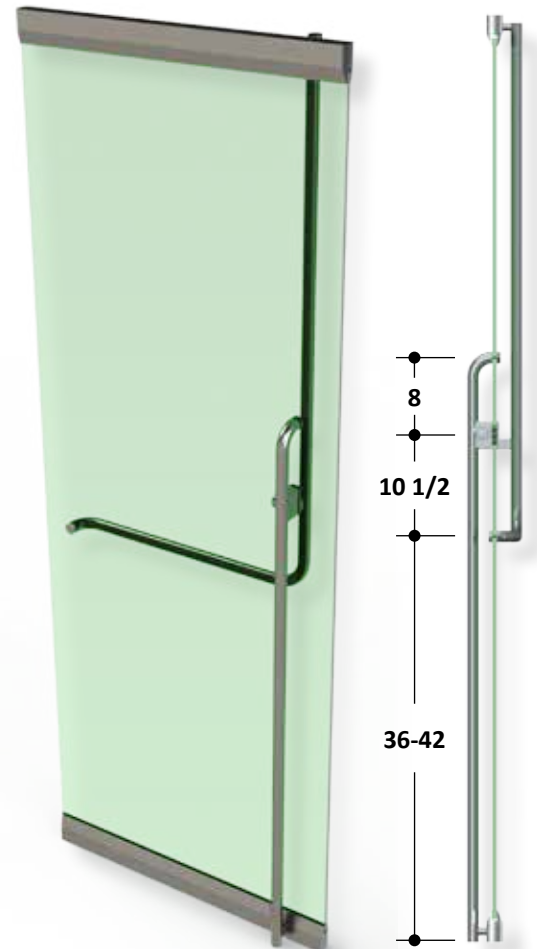
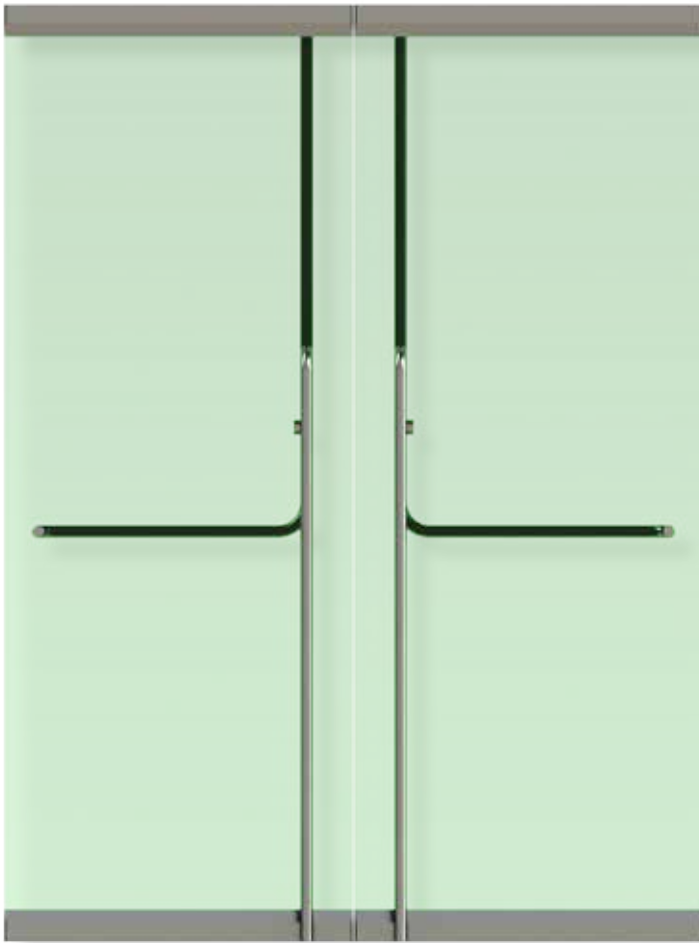

PL100M

Finish

- #4 brushed stainless steel
- #8 polished stainless steel
- Satin brass
- Polished brass
- us10b
- Custom painted

The following list of mortise cylinders will work with PRL Panics and Deadbolts

MFR.	NO.	NOMINAL LENGTH	CAM NO.
Schlage	20-001	1-1/8"	B502-191
Russwin	#0 1/2"	1-1/8"	#1
Corbin	5253	1-1/8"	#1
Sargent	41	1-1/8"	X13000
Best	1E64	1-1/8"	1EC4
Yale	1152	1-1/8"	1161 (std.)
Lori	218	1-1/8"	4400-00-3002

Removable core mortise cylinders and thumb-turns will function properly when fitted with one of the listed straight cams. Custom cylinder collars are available to accommodate cylinder lengths exceeding 1-1/8"

PRL GLASS SYSTEMS

PL100 PANIC HANDLE CONFIGURATIONS

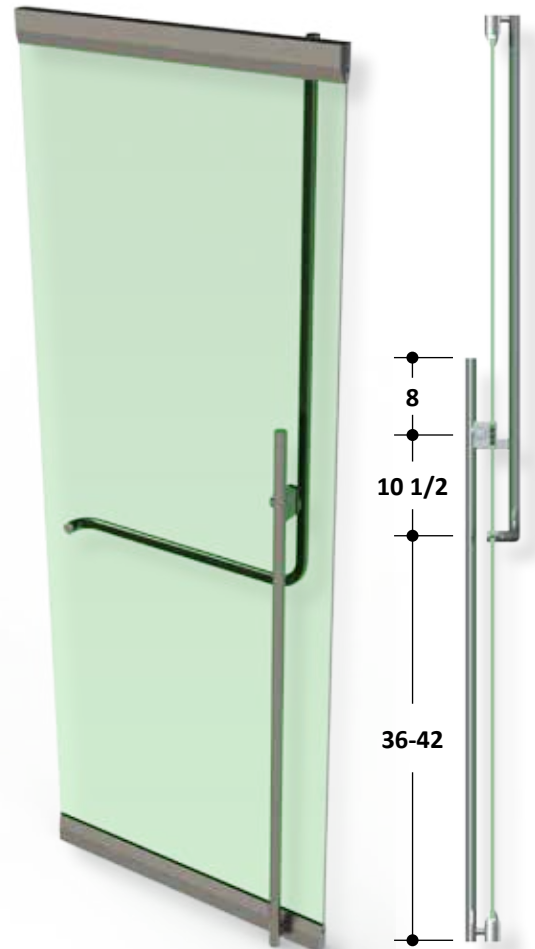
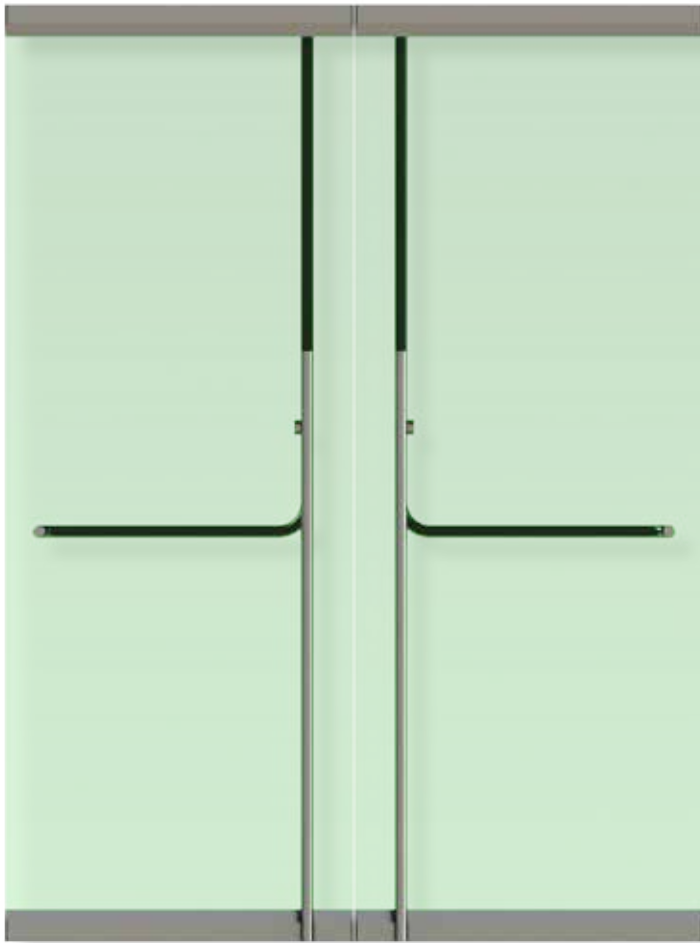

PL100MS

Finish

- #4 brushed stainless steel
- #8 polished stainless steel
- Satin brass
- Polished brass
- us10b
- Custom painted

The following list of mortise cylinders will work with PRL Panics and Deadbolts

MFR.	NO.	NOMINAL LENGTH	CAM NO.
Schlage	20-001	1-1/8"	B502-191
Russwin	#0 1/2"	1-1/8"	#1
Corbin	5253	1-1/8"	#1
Sargent	41	1-1/8"	X13000
Best	1E64	1-1/8"	1EC4
Yale	1152	1-1/8"	1161 (std.)
Lori	218	1-1/8"	4400-00-3002

Removable core mortise cylinders and thumb-turns will function properly when fitted with one of the listed straight cams. Custom cylinder collars are available to accommodate cylinder lengths exceeding 1-1/8"

PRL GLASS SYSTEMS

PL100 PANIC HANDLE CONFIGURATIONS

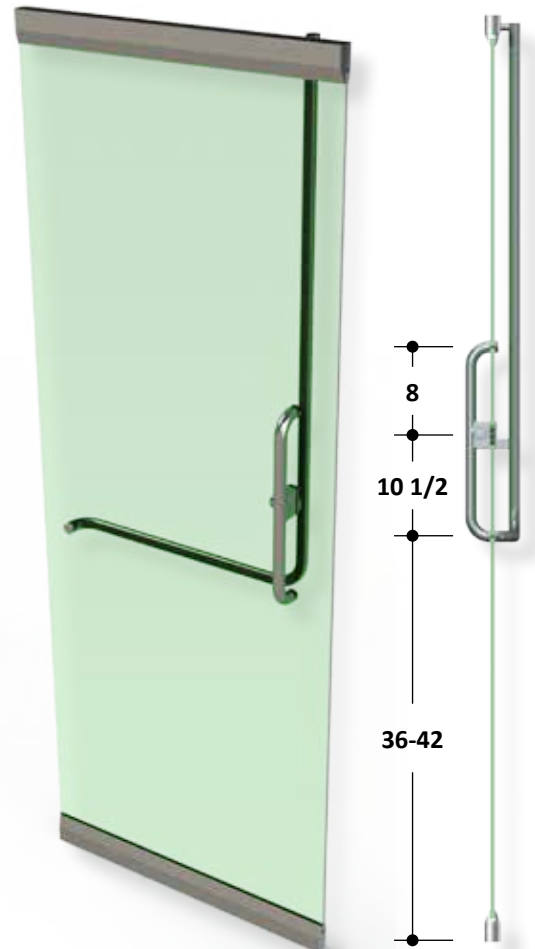
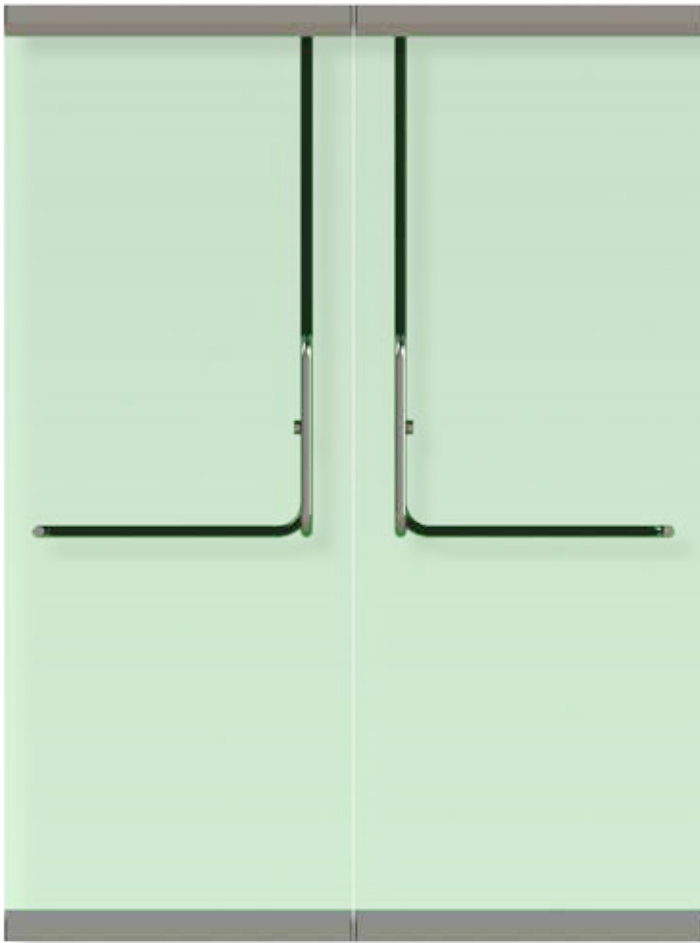

PL100X

Finish

- #4 brushed stainless steel
- #8 polished stainless steel
- Satin brass
- Polished brass
- us10b
- Custom painted

The following list of mortise cylinders will work with PRL Panics and Deadbolts

MFR.	NO.	NOMINAL LENGTH	CAM NO.
Schlage	20-001	1-1/8"	B502-191
Russwin	#0 1/2"	1-1/8"	#1
Corbin	5253	1-1/8"	#1
Sargent	41	1-1/8"	X13000
Best	1E64	1-1/8"	1EC4
Yale	1152	1-1/8"	1161 (std.)
Lori	218	1-1/8"	4400-00-3002

Removable core mortise cylinders and thumb-turns will function properly when fitted with one of the listed straight cams. Custom cylinder collars are available to accommodate cylinder lengths exceeding 1-1/8"

PRL GLASS SYSTEMS

PL100 PANIC HANDLE CONFIGURATIONS

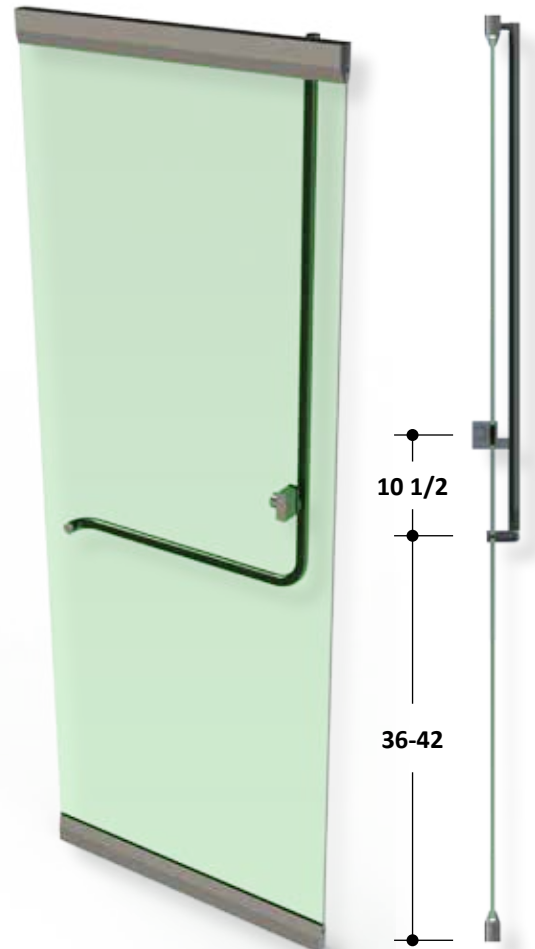
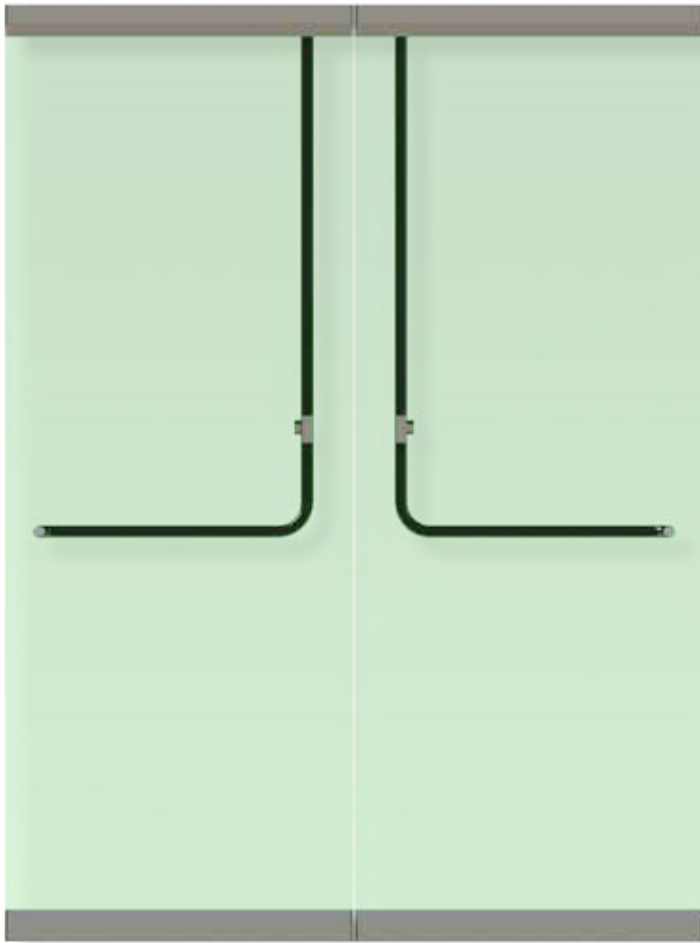

PL100Z

Finish

- #4 brushed stainless steel
- #8 polished stainless steel
- Satin brass
- Polished brass
- us10b
- Custom painted

The following list of mortise cylinders will work with PRL Panics and Deadbolts

MFR.	NO.	NOMINAL LENGTH	CAM NO.
Schlage	20-001	1-1/8"	B502-191
Russwin	#0 1/2"	1-1/8"	#1
Corbin	5253	1-1/8"	#1
Sargent	41	1-1/8"	X13000
Best	1E64	1-1/8"	1EC4
Yale	1152	1-1/8"	1161 (std.)
Lori	218	1-1/8"	4400-00-3002

Removable core mortise cylinders and thumb-turns will function properly when fitted with one of the listed straight cams. Custom cylinder collars are available to accommodate cylinder lengths exceeding 1-1/8"

PRL GLASS SYSTEMS

PL100 PANIC HANDLE CONFIGURATIONS

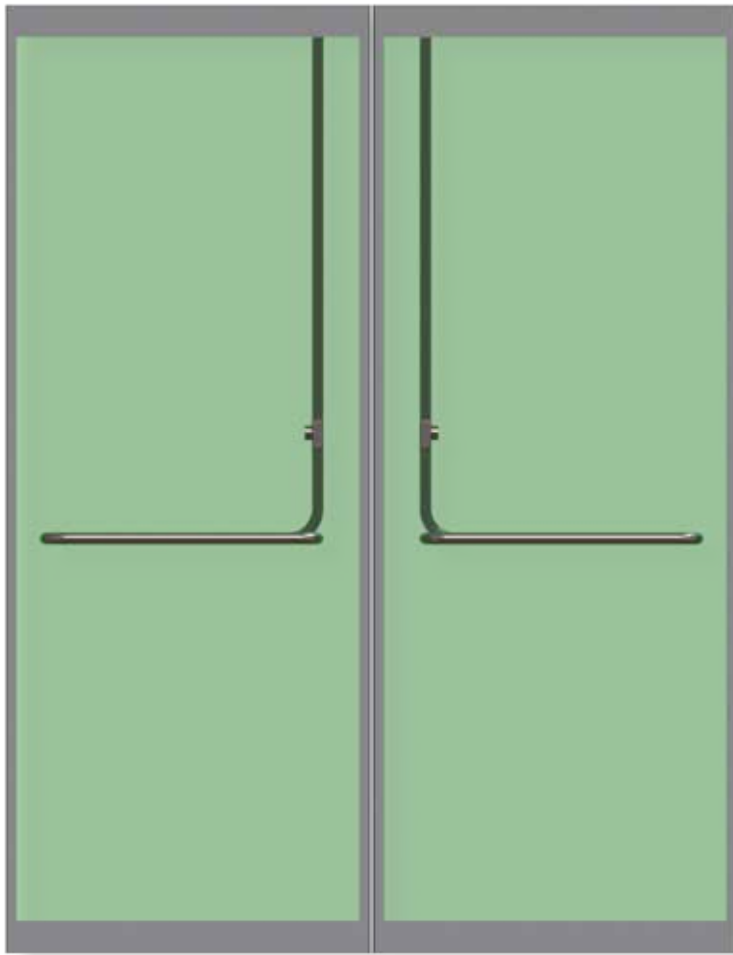

PL100A

Finish

- #4 brushed stainless steel
- #8 polished stainless steel
- Satin brass
- Polished brass
- us10b
- Custom painted

The following list of mortise cylinders will work with PRL Panics and Deadbolts

MFR.	NO.	NOMINAL LENGTH	CAM NO.
Schlage	20-001	1-1/8"	B502-191
Russwin	#0 1/2"	1-1/8"	#1
Corbin	5253	1-1/8"	#1
Sargent	41	1-1/8"	X13000
Best	1E64	1-1/8"	1EC4
Yale	1152	1-1/8"	1161 (std.)
Lori	218	1-1/8"	4400-00-3002

Removable core mortise cylinders and thumb-turns will function properly when fitted with one of the listed straight cams. Custom cylinder collars are available to accommodate cylinder lengths exceeding 1-1/8"

PRL GLASS SYSTEMS

PL100 PANIC HANDLE CONFIGURATIONS

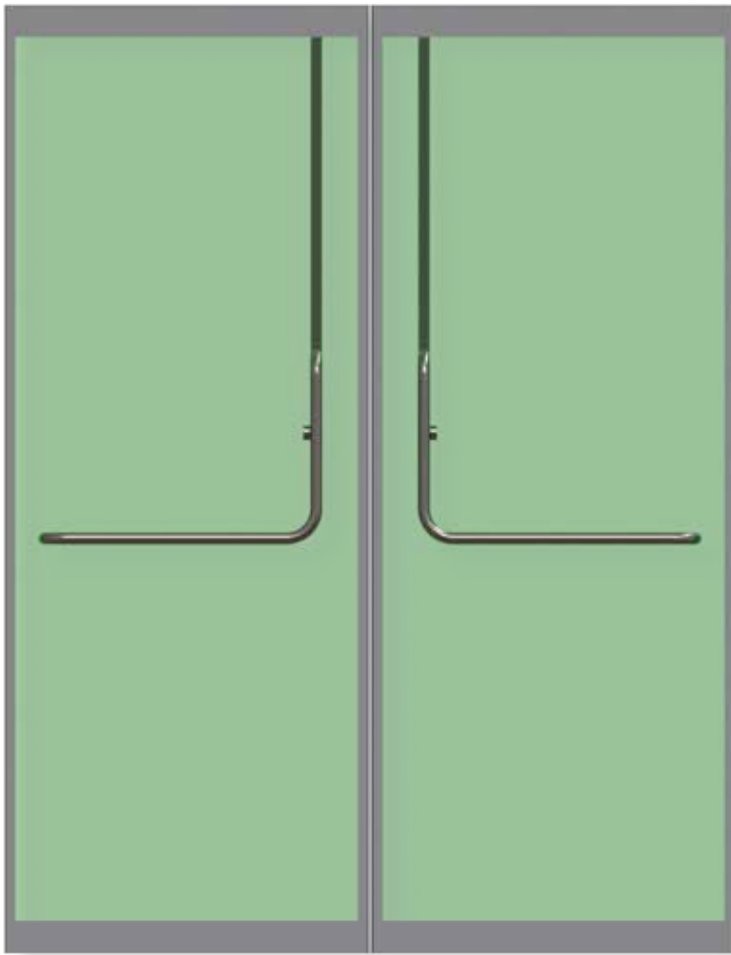

PL100B

Finish

- #4 brushed stainless steel
- #8 polished stainless steel
- Satin brass
- Polished brass
- us10b
- Custom painted

The following list of mortise cylinders will work with PRL Panics and Deadbolts

MFR.	NO.	NOMINAL LENGTH	CAM NO.
Schlage	20-001	1-1/8"	B502-191
Russwin	#0 1/2"	1-1/8"	#1
Corbin	5253	1-1/8"	#1
Sargent	41	1-1/8"	X13000
Best	1E64	1-1/8"	1EC4
Yale	1152	1-1/8"	1161 (std.)
Lori	218	1-1/8"	4400-00-3002

Removable core mortise cylinders and thumb-turns will function properly when fitted with one of the listed straight cams. Custom cylinder collars are available to accommodate cylinder lengths exceeding 1-1/8"

PRL GLASS SYSTEMS

PL100 PANIC HANDLE CONFIGURATIONS

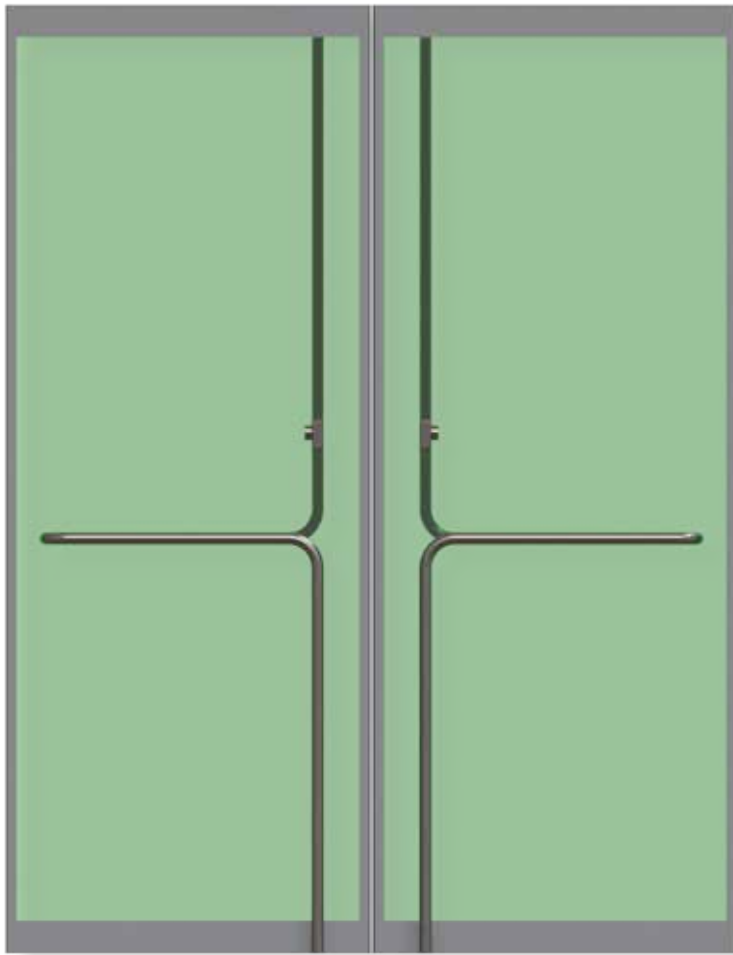

PL100C

Finish

- #4 brushed stainless steel
- #8 polished stainless steel
- Satin brass
- Polished brass
- us10b
- Custom painted

The following list of mortise cylinders will work with PRL Panics and Deadbolts

MFR.	NO.	NOMINAL LENGTH	CAM NO.
Schlage	20-001	1-1/8"	B502-191
Russwin	#0 1/2"	1-1/8"	#1
Corbin	5253	1-1/8"	#1
Sargent	41	1-1/8"	X13000
Best	1E64	1-1/8"	1EC4
Yale	1152	1-1/8"	1161 (std.)
Lori	218	1-1/8"	4400-00-3002

Removable core mortise cylinders and thumb-turns will function properly when fitted with one of the listed straight cams. Custom cylinder collars are available to accommodate cylinder lengths exceeding 1-1/8"

PRL GLASS SYSTEMS

PL100 PANIC HANDLE CONFIGURATIONS

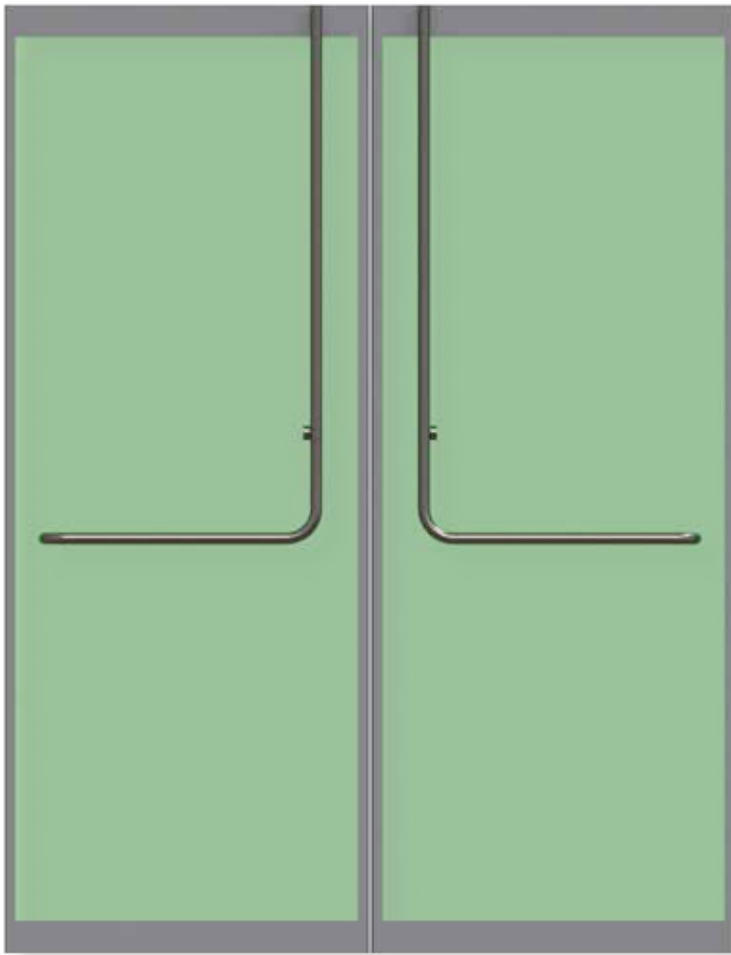

PL100D

Finish

- #4 brushed stainless steel
- #8 polished stainless steel
- Satin brass
- Polished brass
- us10b
- Custom painted

The following list of mortise cylinders will work with PRL Panics and Deadbolts

MFR.	NO.	NOMINAL LENGTH	CAM NO.
Schlage	20-001	1-1/8"	B502-191
Russwin	#0 1/2"	1-1/8"	#1
Corbin	5253	1-1/8"	#1
Sargent	41	1-1/8"	X13000
Best	1E64	1-1/8"	1EC4
Yale	1152	1-1/8"	1161 (std.)
Lori	218	1-1/8"	4400-00-3002

Removable core mortise cylinders and thumb-turns will function properly when fitted with one of the listed straight cams. Custom cylinder collars are available to accommodate cylinder lengths exceeding 1-1/8"

PRL GLASS SYSTEMS

PL100 PANIC HANDLE CONFIGURATIONS

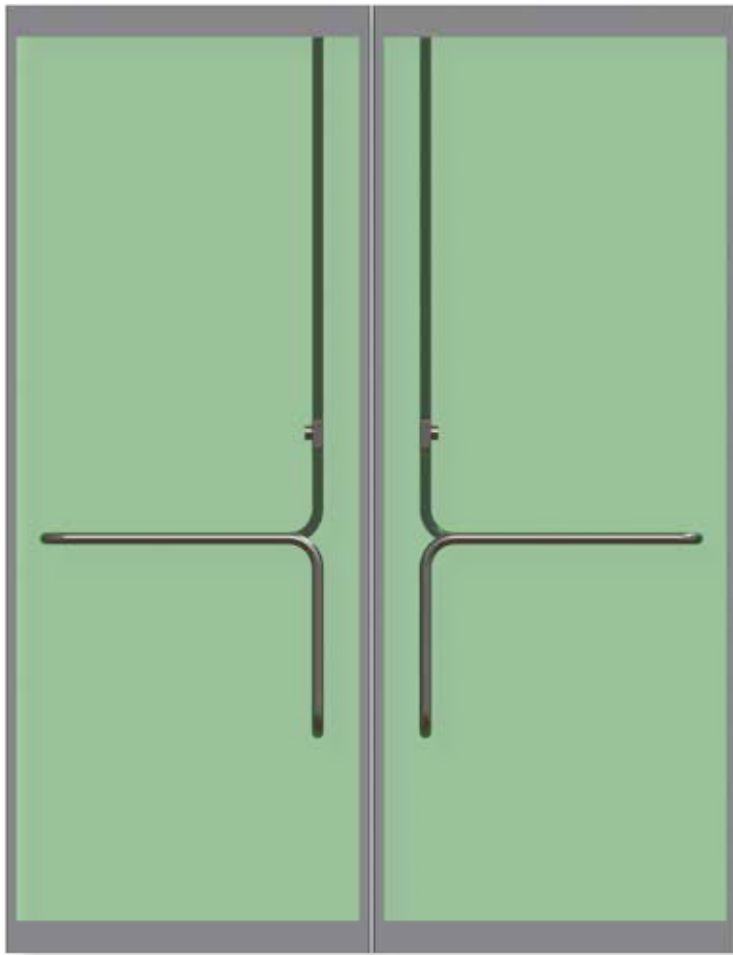

PL100E

Finish

- #4 brushed stainless steel
- #8 polished stainless steel
- Satin brass
- Polished brass
- us10b
- Custom painted

The following list of mortise cylinders will work with PRL Panics and Deadbolts

MFR.	NO.	NOMINAL LENGTH	CAM NO.
Schlage	20-001	1-1/8"	B502-191
Russwin	#0 1/2"	1-1/8"	#1
Corbin	5253	1-1/8"	#1
Sargent	41	1-1/8"	X13000
Best	1E64	1-1/8"	1EC4
Yale	1152	1-1/8"	1161 (std.)
Lori	218	1-1/8"	4400-00-3002

Removable core mortise cylinders and thumb-turns will function properly when fitted with one of the listed straight cams. Custom cylinder collars are available to accommodate cylinder lengths exceeding 1-1/8"

PRL GLASS SYSTEMS

PL100 PANIC HANDLE CONFIGURATIONS

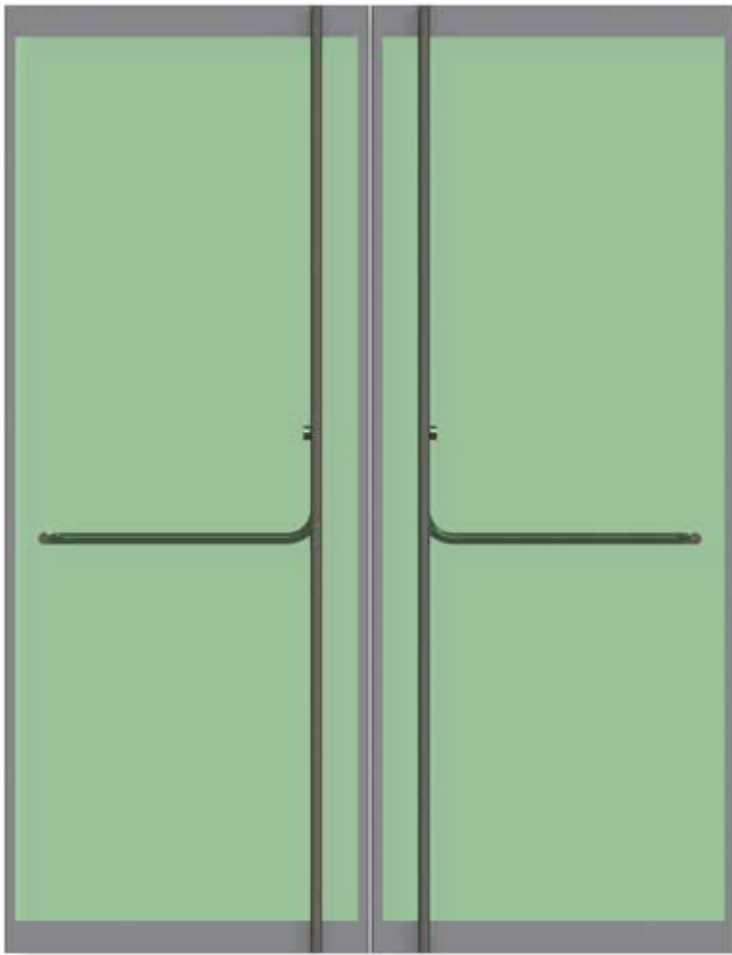

PL100F

Finish

- #4 brushed stainless steel
- #8 polished stainless steel
- Satin brass
- Polished brass
- us10b
- Custom painted

The following list of mortise cylinders will work with PRL Panics and Deadbolts

MFR.	NO.	NOMINAL LENGTH	CAM NO.
Schlage	20-001	1-1/8"	B502-191
Russwin	#0 1/2"	1-1/8"	#1
Corbin	5253	1-1/8"	#1
Sargent	41	1-1/8"	X13000
Best	1E64	1-1/8"	1EC4
Yale	1152	1-1/8"	1161 (std.)
Lori	218	1-1/8"	4400-00-3002

Removable core mortise cylinders and thumb-turns will function properly when fitted with one of the listed straight cams. Custom cylinder collars are available to accommodate cylinder lengths exceeding 1-1/8"

PRL GLASS SYSTEMS

PL100 PANIC HANDLE CONFIGURATIONS

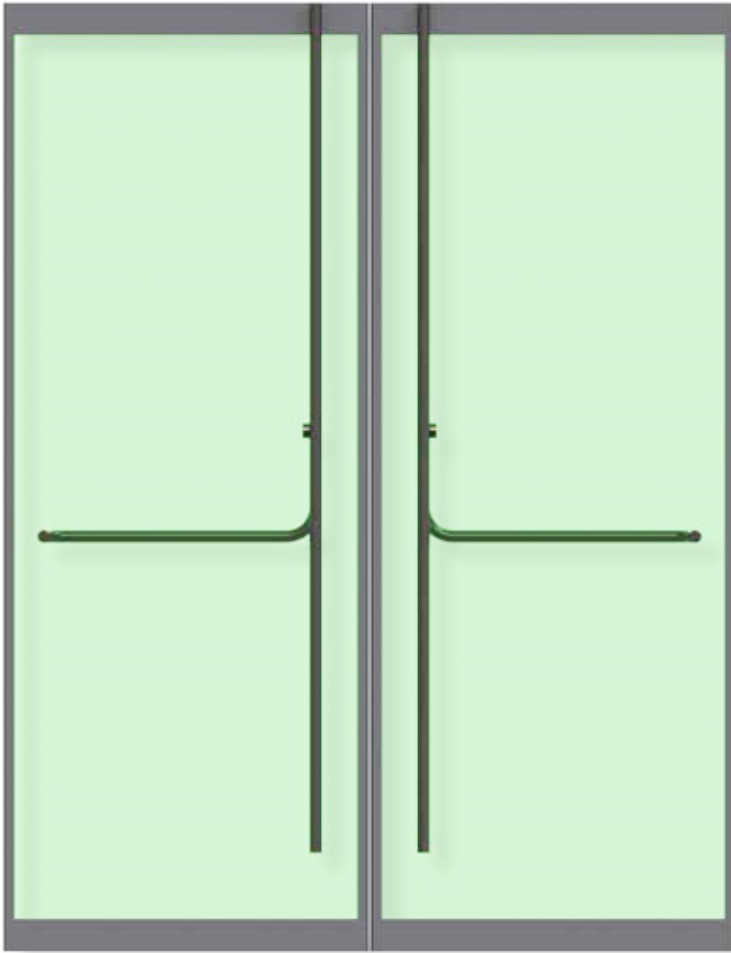

PL100FADA

Finish

- #4 brushed stainless steel
- #8 polished stainless steel
- Satin brass
- Polished brass
- us10b
- Custom painted

The following list of mortise cylinders will work with PRL Panics and Deadbolts

MFR.	NO.	NOMINAL LENGTH	CAM NO.
Schlage	20-001	1-1/8"	B502-191
Russwin	#0 1/2"	1-1/8"	#1
Corbin	5253	1-1/8"	#1
Sargent	41	1-1/8"	X13000
Best	1E64	1-1/8"	1EC4
Yale	1152	1-1/8"	1161 (std.)
Lori	218	1-1/8"	4400-00-3002

Removable core mortise cylinders and thumb-turns will function properly when fitted with one of the listed straight cams. Custom cylinder collars are available to accommodate cylinder lengths exceeding 1-1/8"

PRL GLASS SYSTEMS

PL100 PANIC HANDLE CONFIGURATIONS

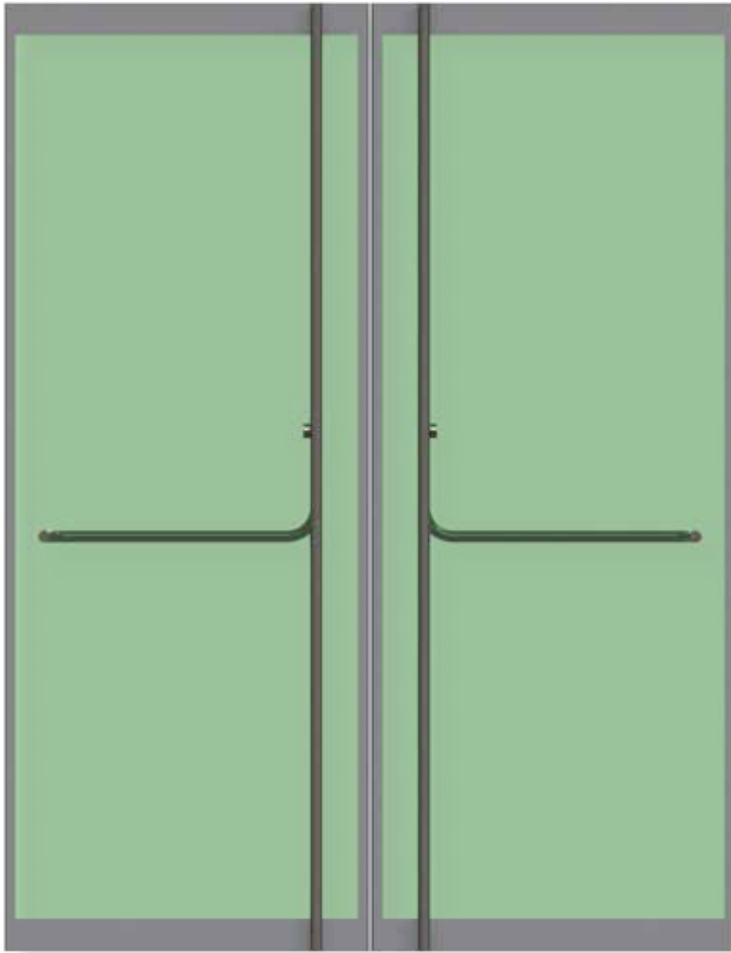

PL100F10

Finish

- #4 brushed stainless steel
- #8 polished stainless steel
- Satin brass
- Polished brass
- us10b
- Custom painted

The PL100F10 is a heavy duty panic handle designed for over sized doors up to 120" tall by using 3/4" tempered glass and a full height "F" exterior handle UL Approved and tested by Architectural testing

The following list of mortise cylinders will work with PRL Panics and Deadbolts

MFR.	NO.	NOMINAL LENGTH	CAM NO.
Schlage	20-001	1-1/8"	B502-191
Russwin	#0 1/2"	1-1/8"	#1
Corbin	5253	1-1/8"	#1
Sargent	41	1-1/8"	X13000
Best	1E64	1-1/8"	1EC4
Yale	1152	1-1/8"	1161 (std.)
Lori	218	1-1/8"	4400-00-3002

Removable core mortise cylinders and thumb-turns will function properly when fitted with one of the listed straight cams. Custom cylinder collars are available to accommodate cylinder lengths exceeding 1-1/8"

PRL GLASS SYSTEMS

PL100 PANIC HANDLE CONFIGURATIONS

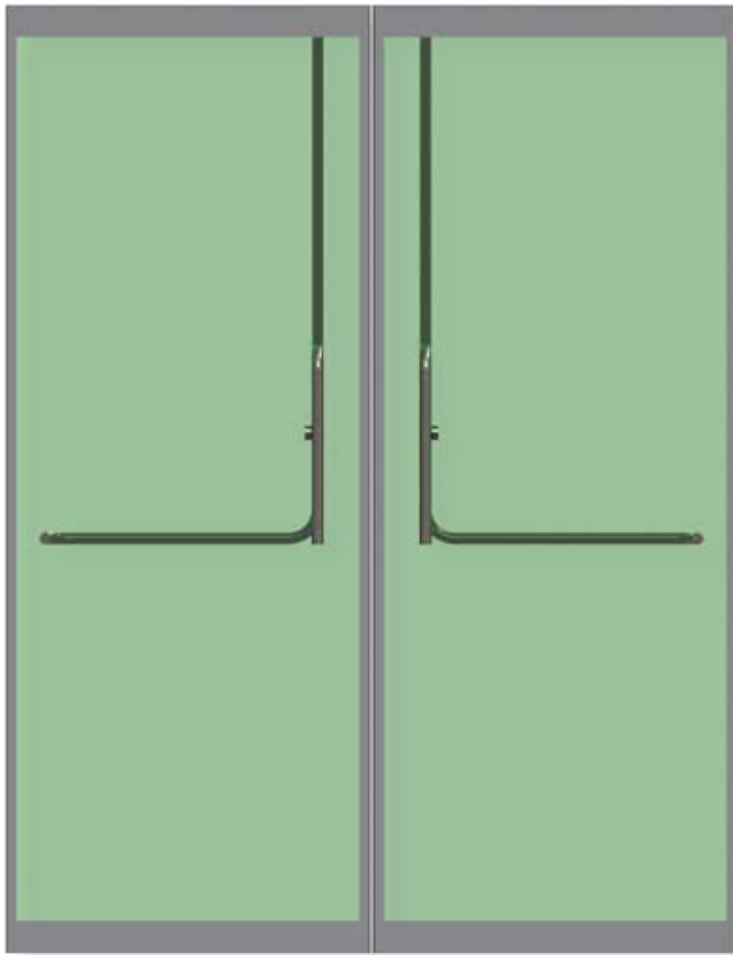

PL100G

Finish

- #4 brushed stainless steel
- #8 polished stainless steel
- Satin brass
- Polished brass
- us10b
- Custom painted

The following list of mortise cylinders will work with PRL Panics and Deadbolts

MFR.	NO.	NOMINAL LENGTH	CAM NO.
Schlage	20-001	1-1/8"	B502-191
Russwin	#0 1/2"	1-1/8"	#1
Corbin	5253	1-1/8"	#1
Sargent	41	1-1/8"	X13000
Best	1E64	1-1/8"	1EC4
Yale	1152	1-1/8"	1161 (std.)
Lori	218	1-1/8"	4400-00-3002

Removable core mortise cylinders and thumb-turns will function properly when fitted with one of the listed straight cams. Custom cylinder collars are available to accommodate cylinder lengths exceeding 1-1/8"

PRL GLASS SYSTEMS

PL100 PANIC HANDLE CONFIGURATIONS

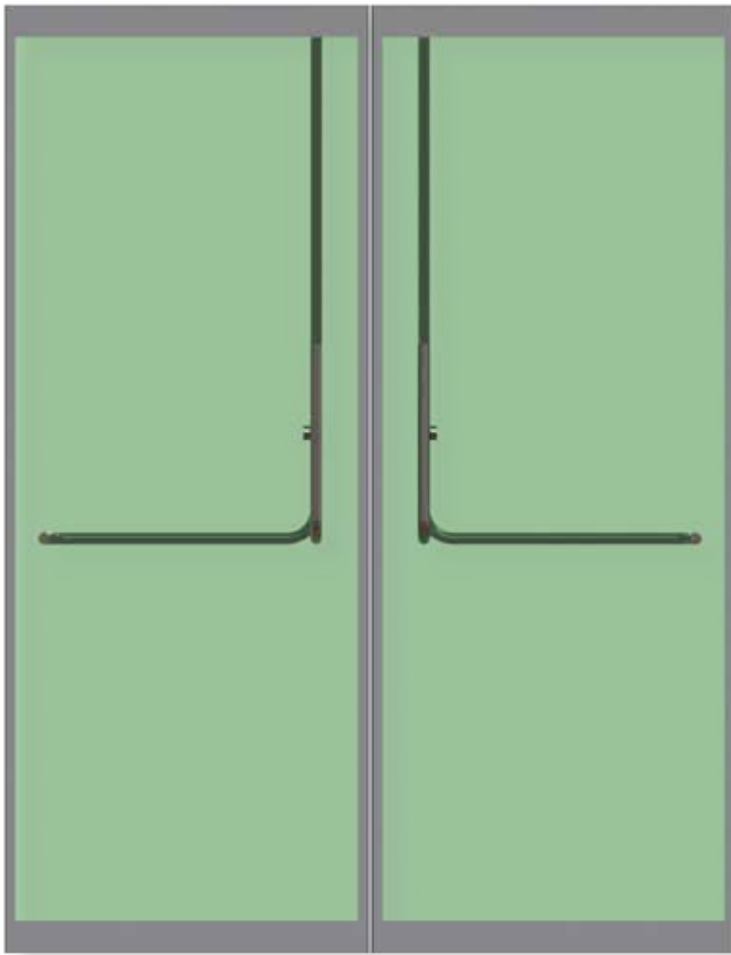

PL100H

Finish

- #4 brushed stainless steel
- #8 polished stainless steel
- Satin brass
- Polished brass
- us10b
- Custom painted

The following list of mortise cylinders will work with PRL Panics and Deadbolts

MFR.	NO.	NOMINAL LENGTH	CAM NO.
Schlage	20-001	1-1/8"	B502-191
Russwin	#0 1/2"	1-1/8"	#1
Corbin	5253	1-1/8"	#1
Sargent	41	1-1/8"	X13000
Best	1E64	1-1/8"	1EC4
Yale	1152	1-1/8"	1161 (std.)
Lori	218	1-1/8"	4400-00-3002

Removable core mortise cylinders and thumb-turns will function properly when fitted with one of the listed straight cams. Custom cylinder collars are available to accommodate cylinder lengths exceeding 1-1/8"

PRL GLASS SYSTEMS

PL100 PANIC HANDLE CONFIGURATIONS

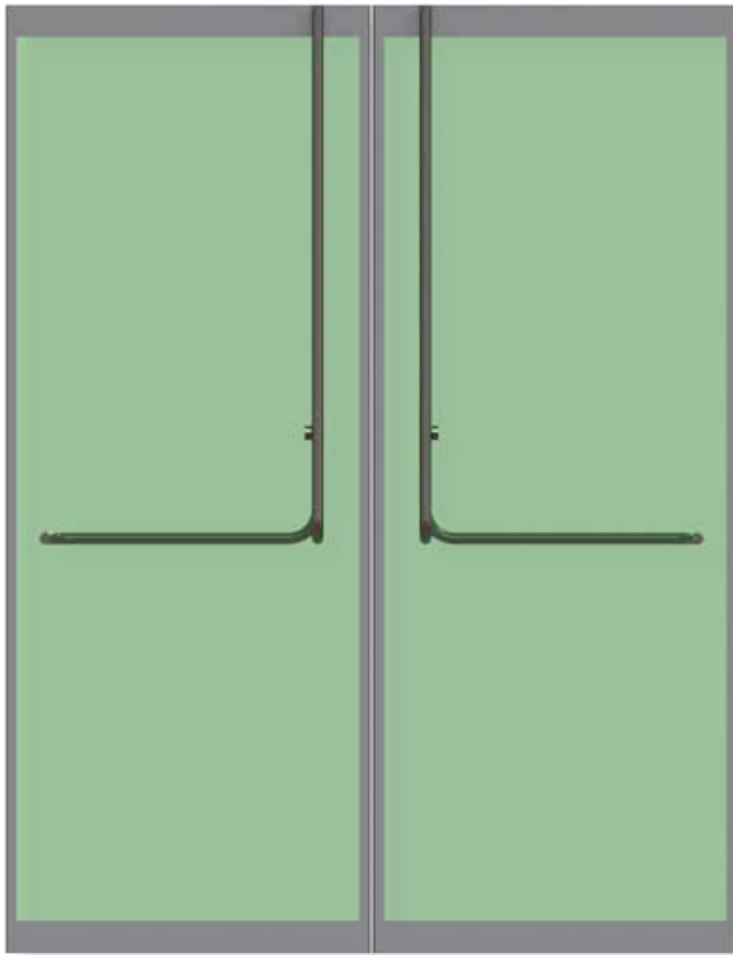

PL100J

Finish

- #4 brushed stainless steel
- #8 polished stainless steel
- Satin brass
- Polished brass
- us10b
- Custom painted

The following list of mortise cylinders will work with PRL Panics and Deadbolts

MFR.	NO.	NOMINAL LENGTH	CAM NO.
Schlage	20-001	1-1/8"	B502-191
Russwin	#0 1/2"	1-1/8"	#1
Corbin	5253	1-1/8"	#1
Sargent	41	1-1/8"	X13000
Best	1E64	1-1/8"	1EC4
Yale	1152	1-1/8"	1161 (std.)
Lori	218	1-1/8"	4400-00-3002

Removable core mortise cylinders and thumb-turns will function properly when fitted with one of the listed straight cams. Custom cylinder collars are available to accommodate cylinder lengths exceeding 1-1/8"

PRL GLASS SYSTEMS

PL100 PANIC HANDLE CONFIGURATIONS

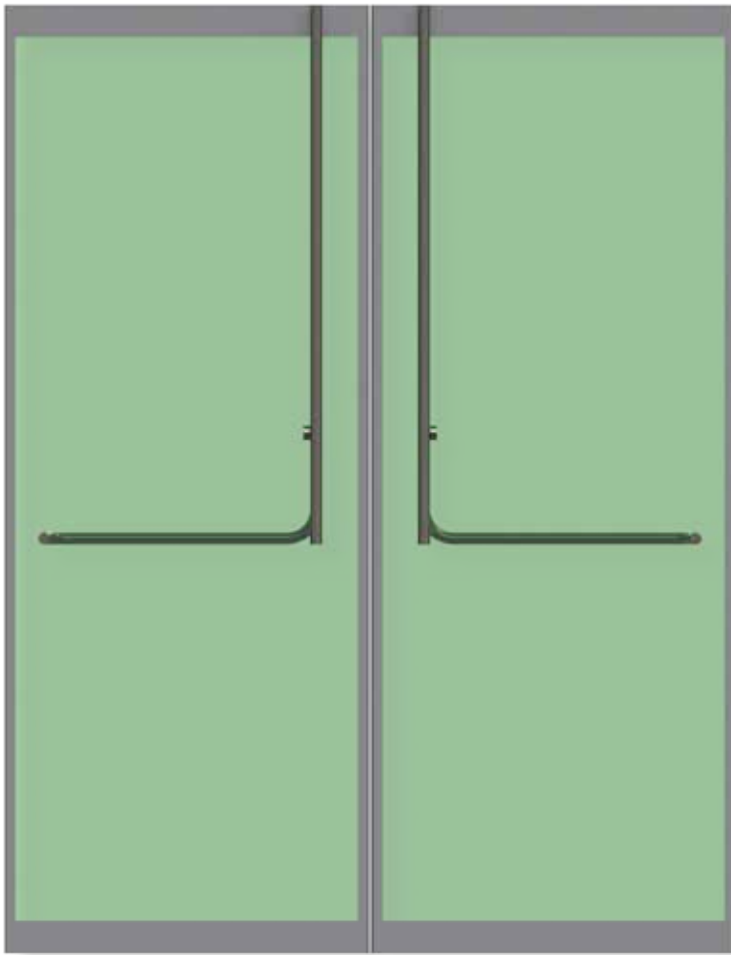

PL100JS

Finish

- #4 brushed stainless steel
- #8 polished stainless steel
- Satin brass
- Polished brass
- us10b
- Custom painted

The following list of mortise cylinders will work with PRL Panics and Deadbolts

MFR.	NO.	NOMINAL LENGTH	CAM NO.
Schlage	20-001	1-1/8"	B502-191
Russwin	#0 1/2"	1-1/8"	#1
Corbin	5253	1-1/8"	#1
Sargent	41	1-1/8"	X13000
Best	1E64	1-1/8"	1EC4
Yale	1152	1-1/8"	1161 (std.)
Lori	218	1-1/8"	4400-00-3002

Removable core mortise cylinders and thumb-turns will function properly when fitted with one of the listed straight cams. Custom cylinder collars are available to accommodate cylinder lengths exceeding 1-1/8"

PRL GLASS SYSTEMS

PL100 PANIC HANDLE CONFIGURATIONS

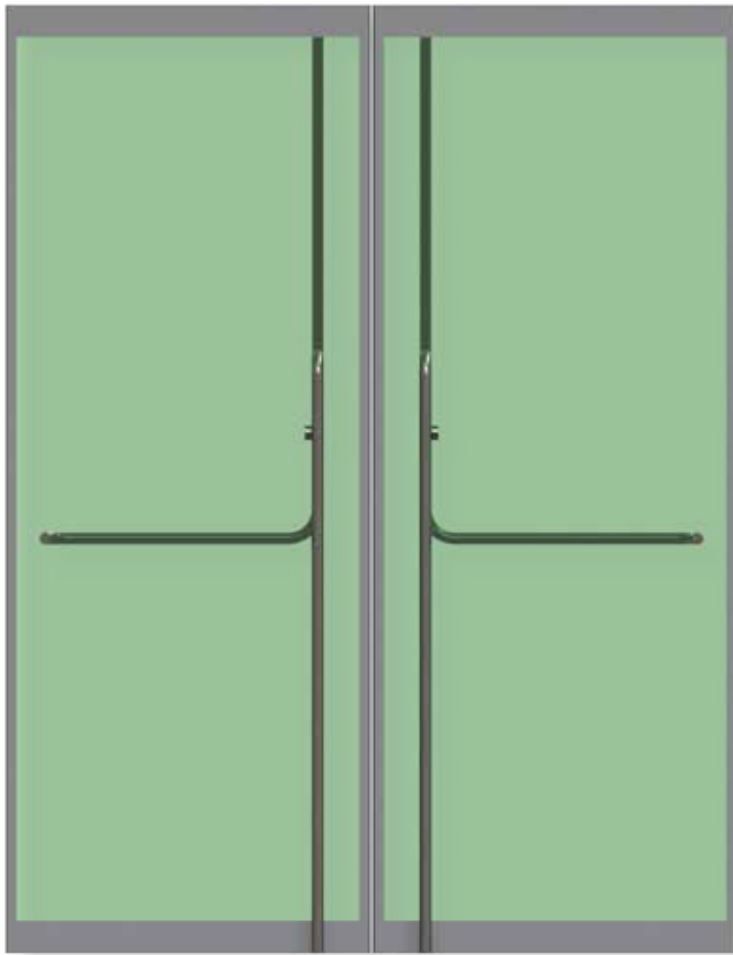

PL100M

Finish

- #4 brushed stainless steel
- #8 polished stainless steel
- Satin brass
- Polished brass
- us10b
- Custom painted

The following list of mortise cylinders will work with PRL Panics and Deadbolts

MFR.	NO.	NOMINAL LENGTH	CAM NO.
Schlage	20-001	1-1/8"	B502-191
Russwin	#0 1/2"	1-1/8"	#1
Corbin	5253	1-1/8"	#1
Sargent	41	1-1/8"	X13000
Best	1E64	1-1/8"	1EC4
Yale	1152	1-1/8"	1161 (std.)
Lori	218	1-1/8"	4400-00-3002

Removable core mortise cylinders and thumb-turns will function properly when fitted with one of the listed straight cams. Custom cylinder collars are available to accommodate cylinder lengths exceeding 1-1/8"

PRL GLASS SYSTEMS

PL100 PANIC HANDLE CONFIGURATIONS

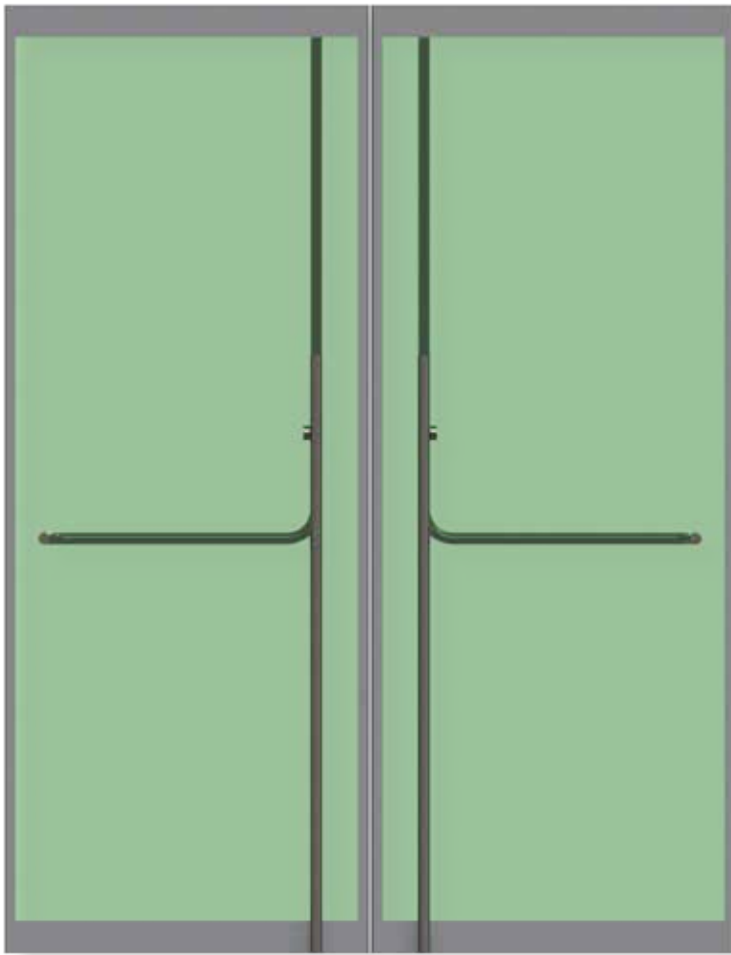

PL100MS

Finish

- #4 brushed stainless steel
- #8 polished stainless steel
- Satin brass
- Polished brass
- us10b
- Custom painted

The following list of mortise cylinders will work with PRL Panics and Deadbolts

MFR.	NO.	NOMINAL LENGTH	CAM NO.
Schlage	20-001	1-1/8"	B502-191
Russwin	#0 1/2"	1-1/8"	#1
Corbin	5253	1-1/8"	#1
Sargent	41	1-1/8"	X13000
Best	1E64	1-1/8"	1EC4
Yale	1152	1-1/8"	1161 (std.)
Lori	218	1-1/8"	4400-00-3002

Removable core mortise cylinders and thumb-turns will function properly when fitted with one of the listed straight cams. Custom cylinder collars are available to accommodate cylinder lengths exceeding 1-1/8"

PRL GLASS SYSTEMS

PL100 PANIC HANDLE CONFIGURATIONS

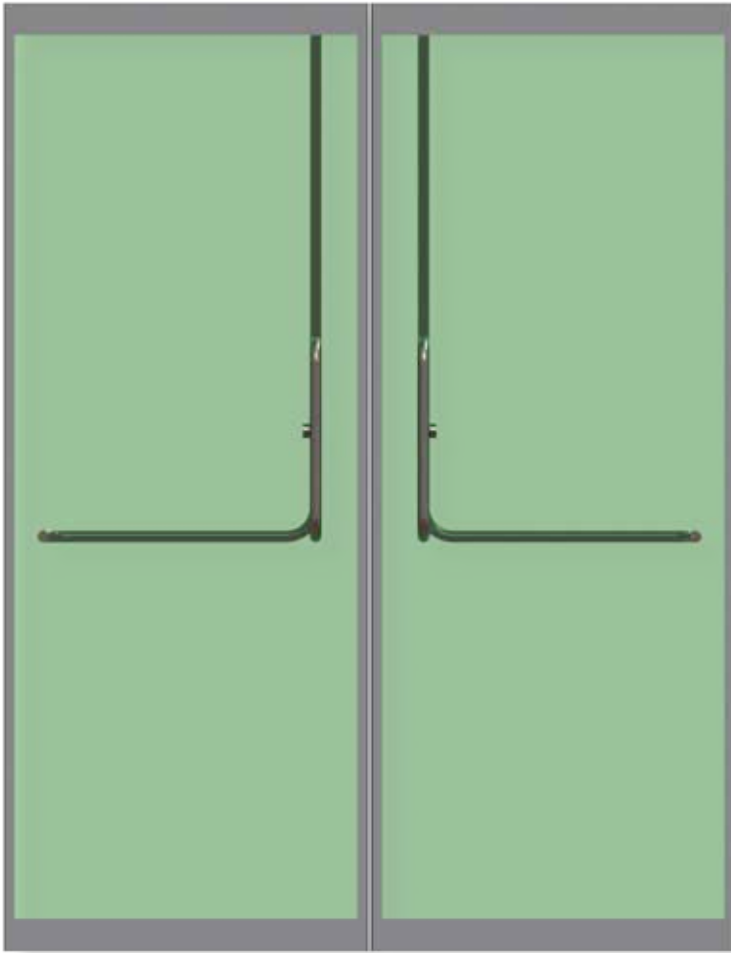

PL100X

Finish

- #4 brushed stainless steel
- #8 polished stainless steel
- Satin brass
- Polished brass
- us10b
- Custom painted

The following list of mortise cylinders will work with PRL Panics and Deadbolts

MFR.	NO.	NOMINAL LENGTH	CAM NO.
Schlage	20-001	1-1/8"	B502-191
Russwin	#0 1/2"	1-1/8"	#1
Corbin	5253	1-1/8"	#1
Sargent	41	1-1/8"	X13000
Best	1E64	1-1/8"	1EC4
Yale	1152	1-1/8"	1161 (std.)
Lori	218	1-1/8"	4400-00-3002

Removable core mortise cylinders and thumb-turns will function properly when fitted with one of the listed straight cams. Custom cylinder collars are available to accommodate cylinder lengths exceeding 1-1/8"

PRL GLASS SYSTEMS

PL100 PANIC HANDLE CONFIGURATIONS

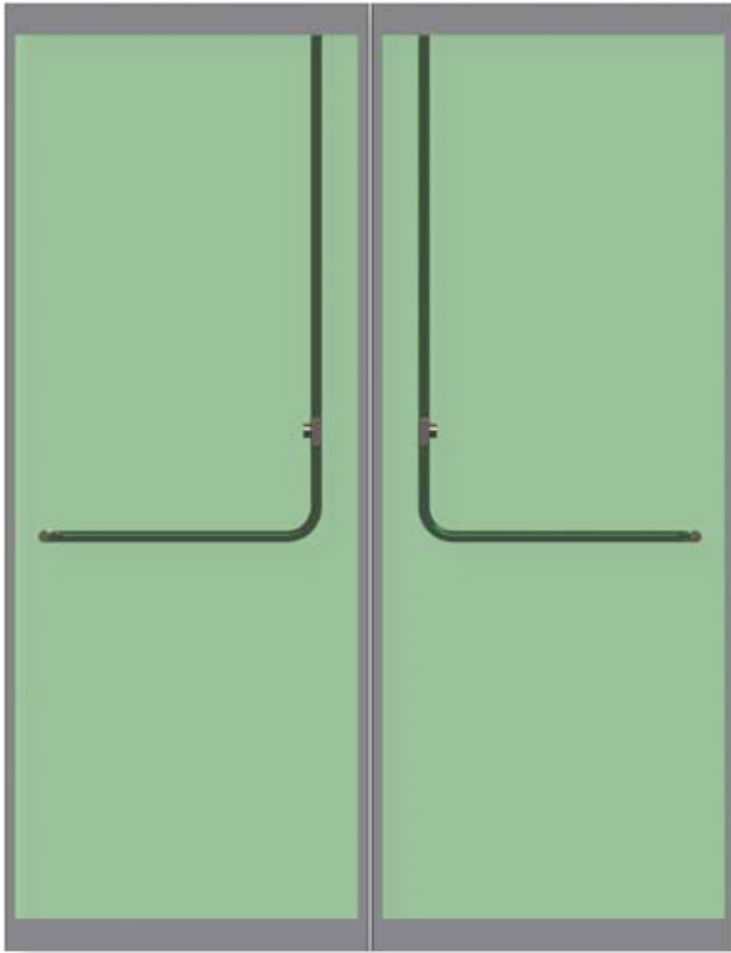

PL100Z

Finish

- #4 brushed stainless steel
- #8 polished stainless steel
- Satin brass
- Polished brass
- us10b
- Custom painted

The following list of mortise cylinders will work with PRL Panics and Deadbolts

MFR.	NO.	NOMINAL LENGTH	CAM NO.
Schlage	20-001	1-1/8"	B502-191
Russwin	#0 1/2"	1-1/8"	#1
Corbin	5253	1-1/8"	#1
Sargent	41	1-1/8"	X13000
Best	1E64	1-1/8"	1EC4
Yale	1152	1-1/8"	1161 (std.)
Lori	218	1-1/8"	4400-00-3002

Removable core mortise cylinders and thumb-turns will function properly when fitted with one of the listed straight cams. Custom cylinder collars are available to accommodate cylinder lengths exceeding 1-1/8"

PRL GLASS SYSTEMS

PL110 PANIC HANDLE CONFIGURATIONS



Panic Handles For Tempered Glass Doors



PRL GLASS SYSTEMS

PL110 PANIC HANDLE CONFIGURATIONS

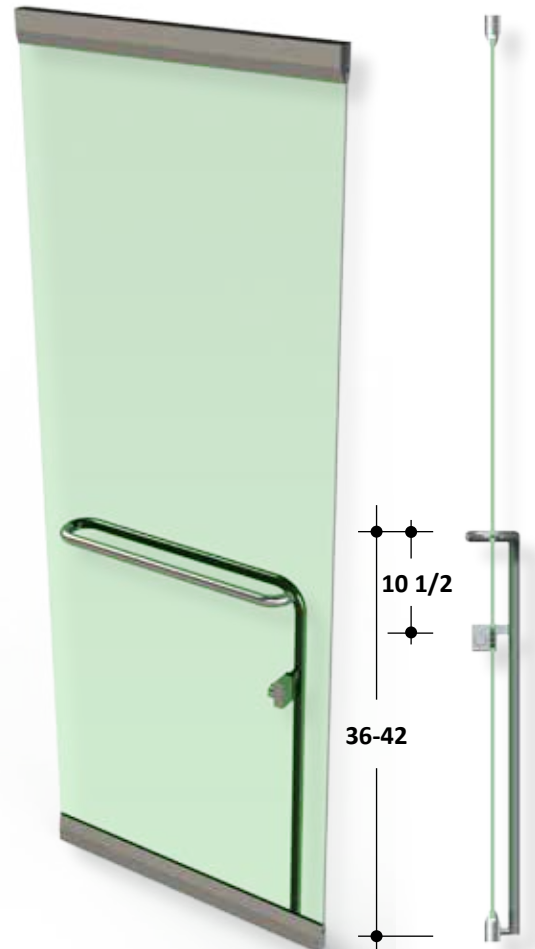
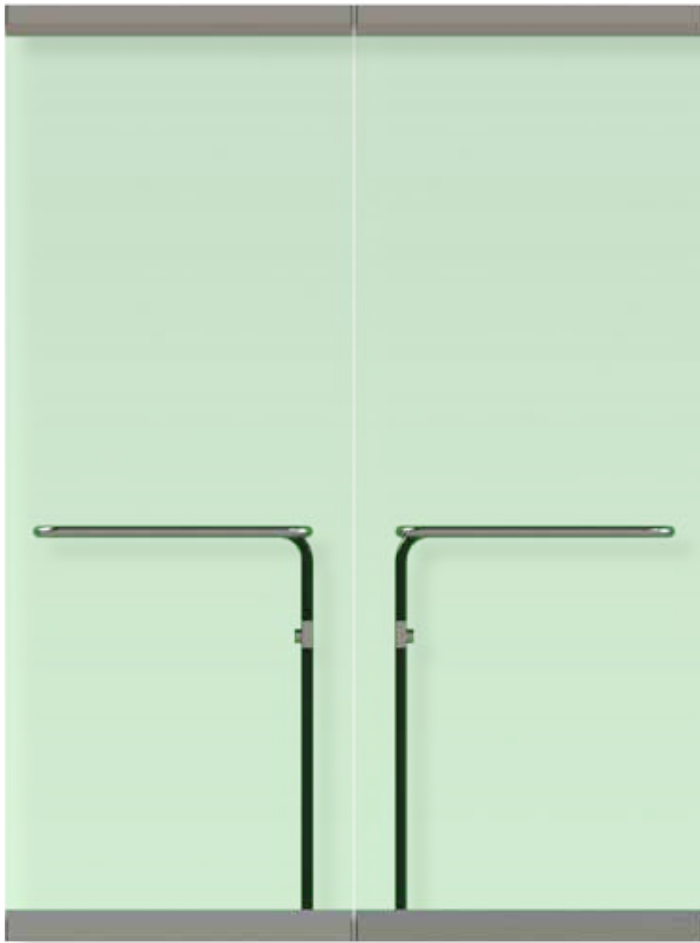

PL110A

Finish

- #4 brushed stainless steel
- #8 polished stainless steel
- Satin brass
- Polished brass
- us10b
- Custom painted

The following list of mortise cylinders will work with PRL Panics and Deadbolts

MFR.	NO.	NOMINAL LENGTH	CAM NO.
Schlage	20-001	1-1/8"	B502-191
Russwin	#0 1/2"	1-1/8"	#1
Corbin	5253	1-1/8"	#1
Sargent	41	1-1/8"	X13000
Best	1E64	1-1/8"	1EC4
Yale	1152	1-1/8"	1161 (std.)
Lori	218	1-1/8"	4400-00-3002

Removable core mortise cylinders and thumb-turns will function properly when fitted with one of the listed straight cams. Custom cylinder collars are available to accommodate cylinder lengths exceeding 1-1/8"

PRL GLASS SYSTEMS

PL110 PANIC HANDLE CONFIGURATIONS

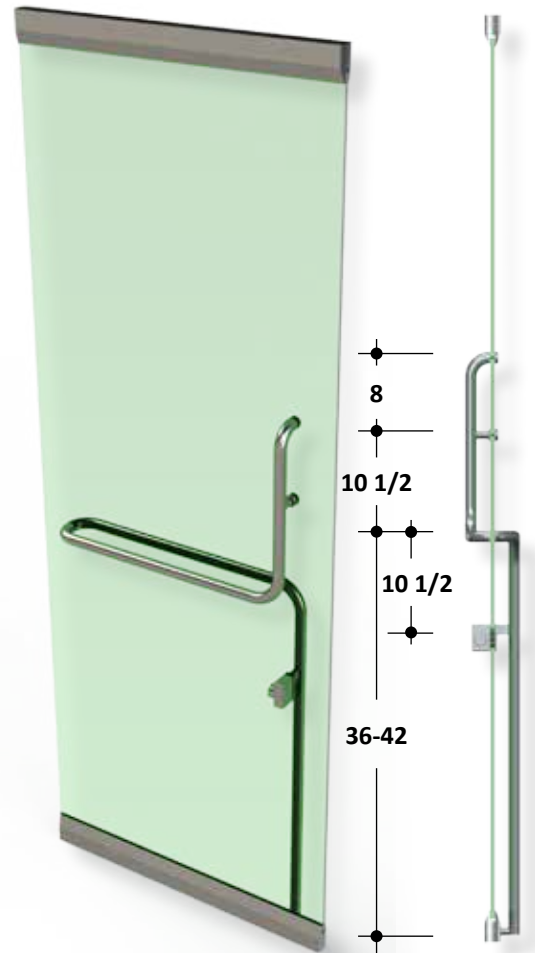
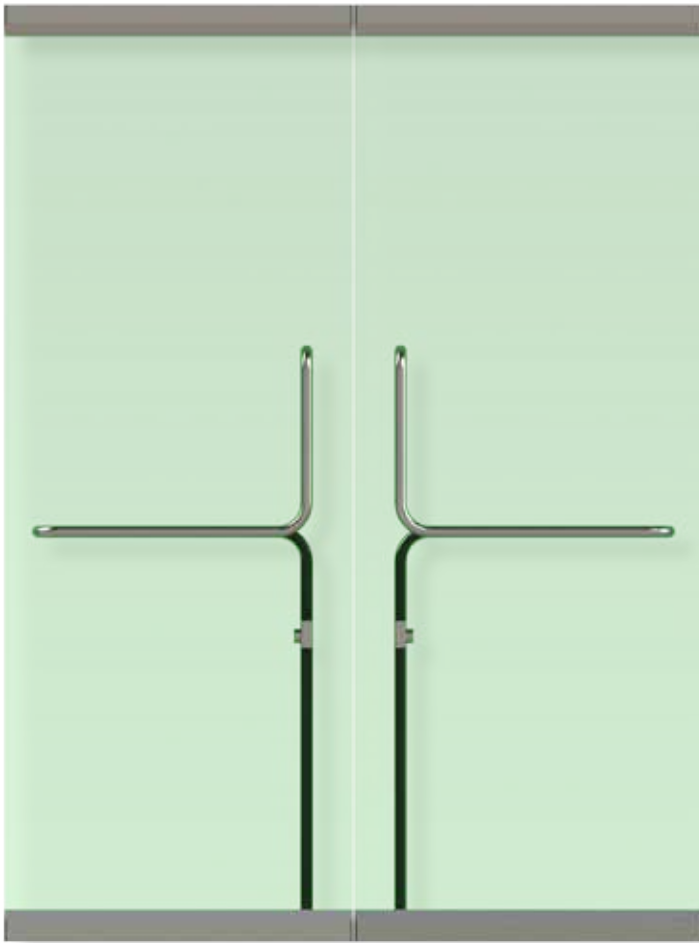

PL110B

Finish

- #4 brushed stainless steel
- #8 polished stainless steel
- Satin brass
- Polished brass
- us10b
- Custom painted

The following list of mortise cylinders will work with PRL Panics and Deadbolts

MFR.	NO.	NOMINAL LENGTH	CAM NO.
Schlage	20-001	1-1/8"	B502-191
Russwin	#0 1/2"	1-1/8"	#1
Corbin	5253	1-1/8"	#1
Sargent	41	1-1/8"	X13000
Best	1E64	1-1/8"	1EC4
Yale	1152	1-1/8"	1161 (std.)
Lori	218	1-1/8"	4400-00-3002

Removable core mortise cylinders and thumb-turns will function properly when fitted with one of the listed straight cams. Custom cylinder collars are available to accommodate cylinder lengths exceeding 1-1/8"

PRL GLASS SYSTEMS

PL110 PANIC HANDLE CONFIGURATIONS

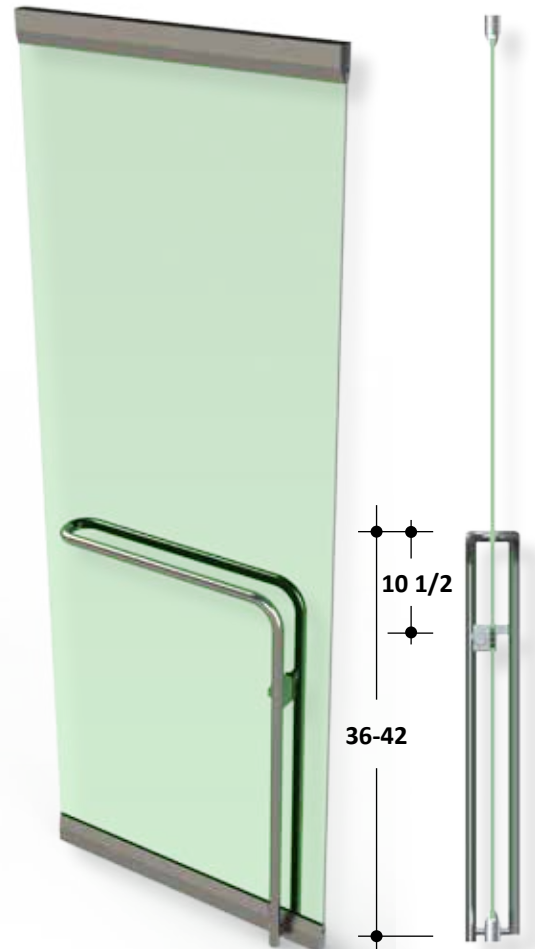
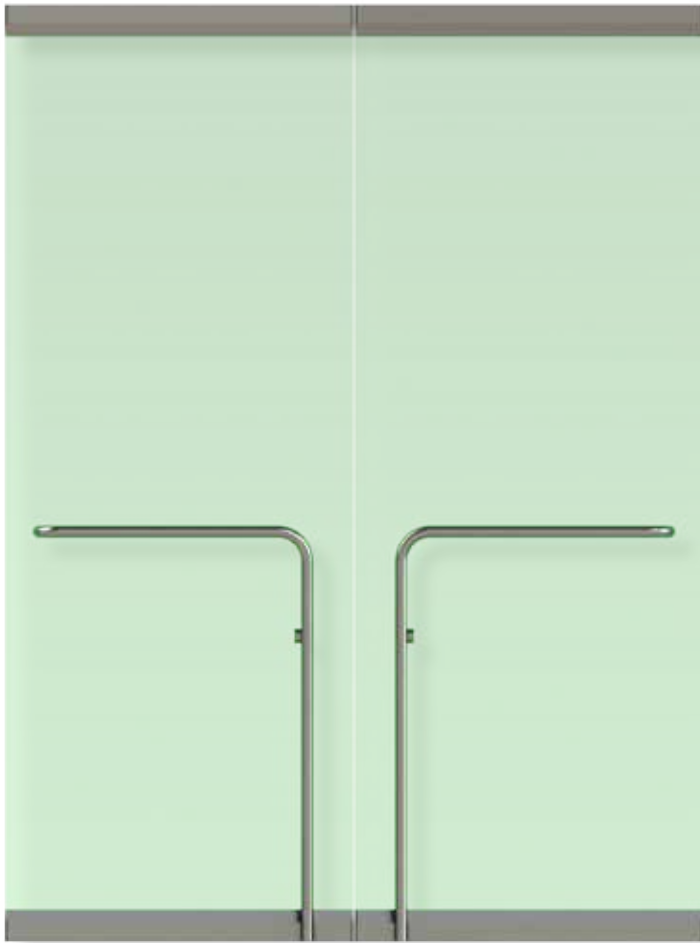

PL110C

Finish

- #4 brushed stainless steel
- #8 polished stainless steel
- Satin brass
- Polished brass
- us10b
- Custom painted

The following list of mortise cylinders will work with PRL Panics and Deadbolts

MFR.	NO.	NOMINAL LENGTH	CAM NO.
Schlage	20-001	1-1/8"	B502-191
Russwin	#0 1/2"	1-1/8"	#1
Corbin	5253	1-1/8"	#1
Sargent	41	1-1/8"	X13000
Best	1E64	1-1/8"	1EC4
Yale	1152	1-1/8"	1161 (std.)
Lori	218	1-1/8"	4400-00-3002

Removable core mortise cylinders and thumb-turns will function properly when fitted with one of the listed straight cams. Custom cylinder collars are available to accommodate cylinder lengths exceeding 1-1/8"

PRL GLASS SYSTEMS

PL110 PANIC HANDLE CONFIGURATIONS

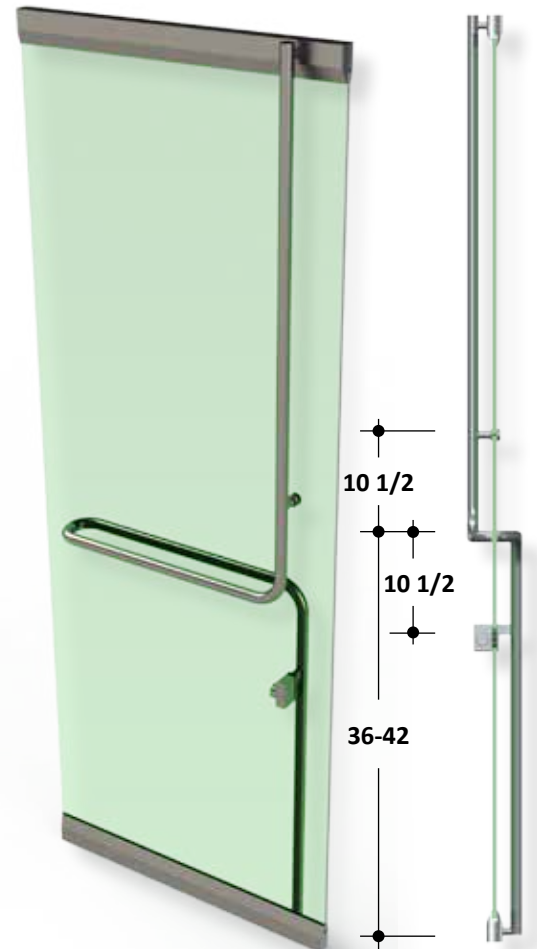
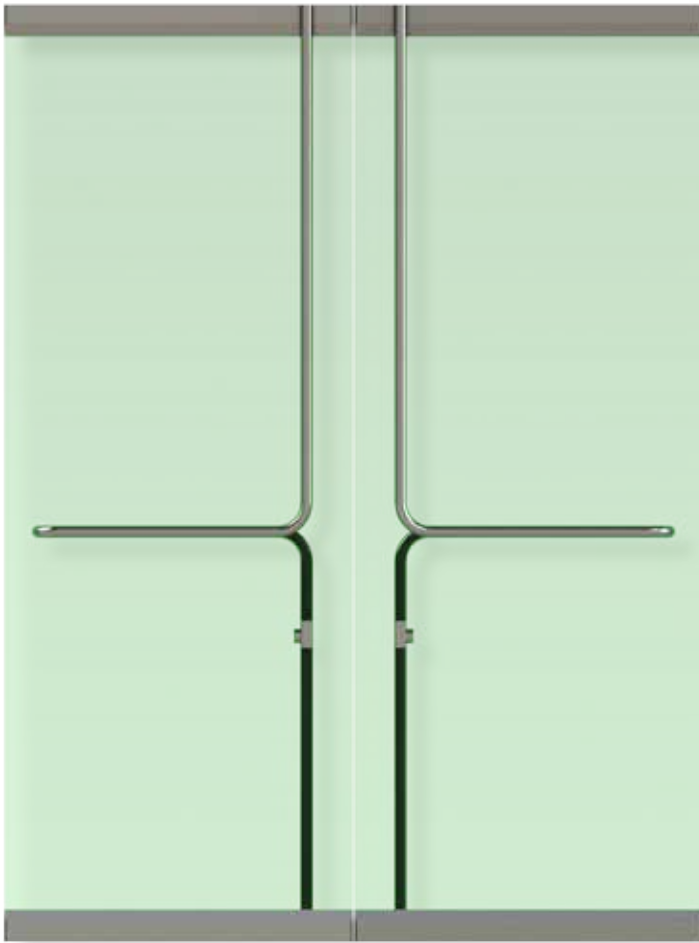

PL110D

Finish

- #4 brushed stainless steel
- #8 polished stainless steel
- Satin brass
- Polished brass
- us10b
- Custom painted

The following list of mortise cylinders will work with PRL Panics and Deadbolts

MFR.	NO.	NOMINAL LENGTH	CAM NO.
Schlage	20-001	1-1/8"	B502-191
Russwin	#0 1/2"	1-1/8"	#1
Corbin	5253	1-1/8"	#1
Sargent	41	1-1/8"	X13000
Best	1E64	1-1/8"	1EC4
Yale	1152	1-1/8"	1161 (std.)
Lori	218	1-1/8"	4400-00-3002

Removable core mortise cylinders and thumb-turns will function properly when fitted with one of the listed straight cams. Custom cylinder collars are available to accommodate cylinder lengths exceeding 1-1/8"

PRL GLASS SYSTEMS

PL110 PANIC HANDLE CONFIGURATIONS

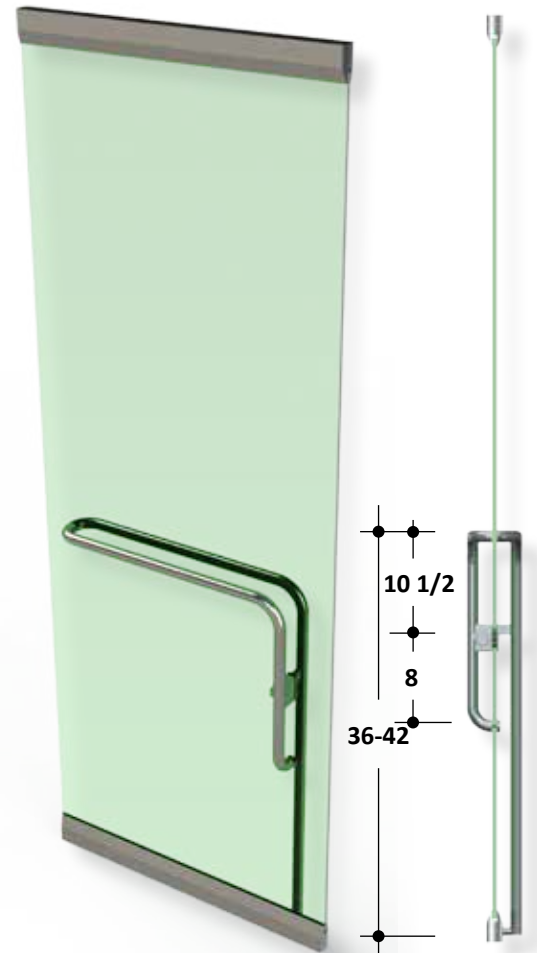
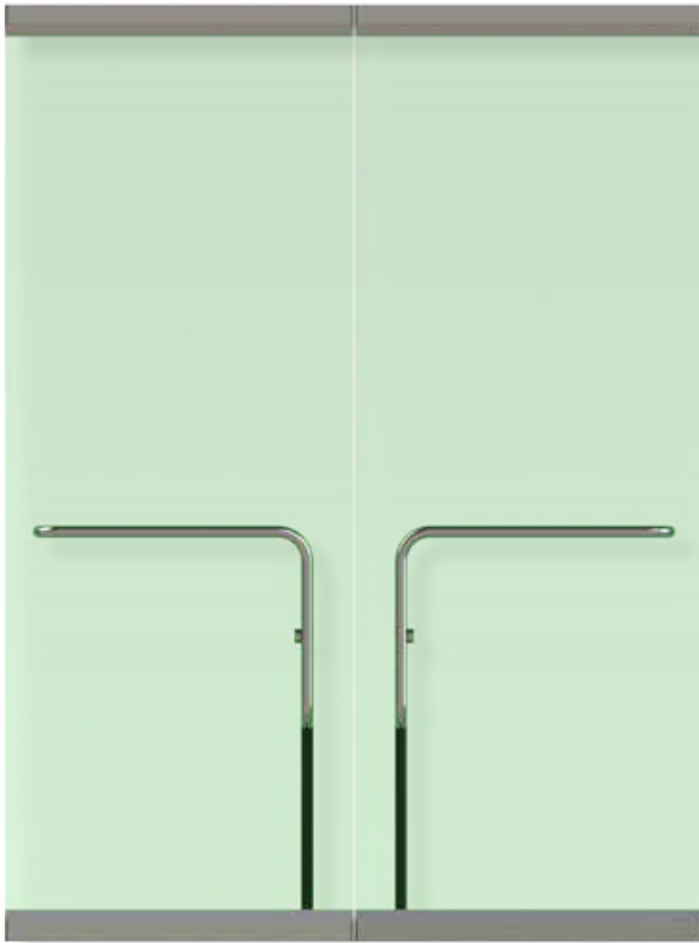

PL110E

Finish

- #4 brushed stainless steel
- #8 polished stainless steel
- Satin brass
- Polished brass
- us10b
- Custom painted

The following list of mortise cylinders will work with PRL Panics and Deadbolts

MFR.	NO.	NOMINAL LENGTH	CAM NO.
Schlage	20-001	1-1/8"	B502-191
Russwin	#0 1/2"	1-1/8"	#1
Corbin	5253	1-1/8"	#1
Sargent	41	1-1/8"	X13000
Best	1E64	1-1/8"	1EC4
Yale	1152	1-1/8"	1161 (std.)
Lori	218	1-1/8"	4400-00-3002

Removable core mortise cylinders and thumb-turns will function properly when fitted with one of the listed straight cams. Custom cylinder collars are available to accommodate cylinder lengths exceeding 1-1/8"

PRL GLASS SYSTEMS

PL110 PANIC HANDLE CONFIGURATIONS

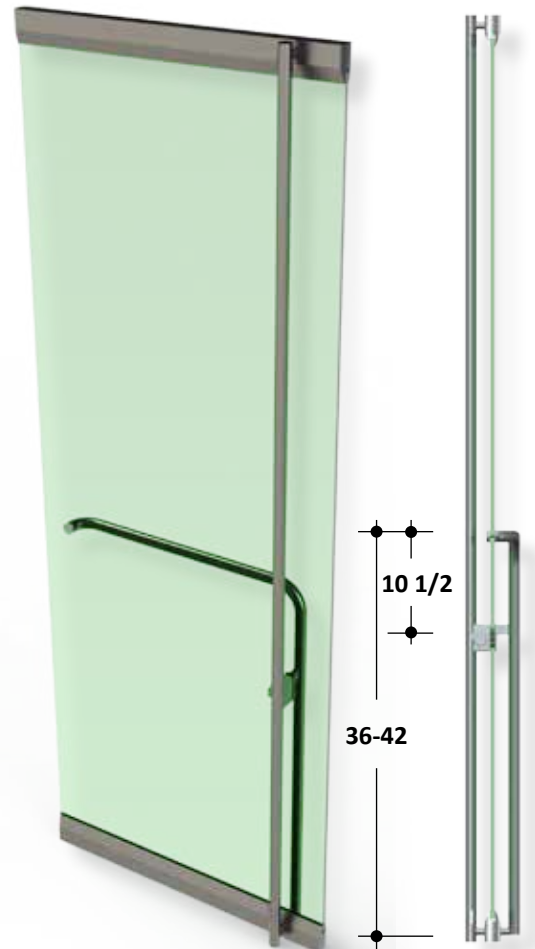
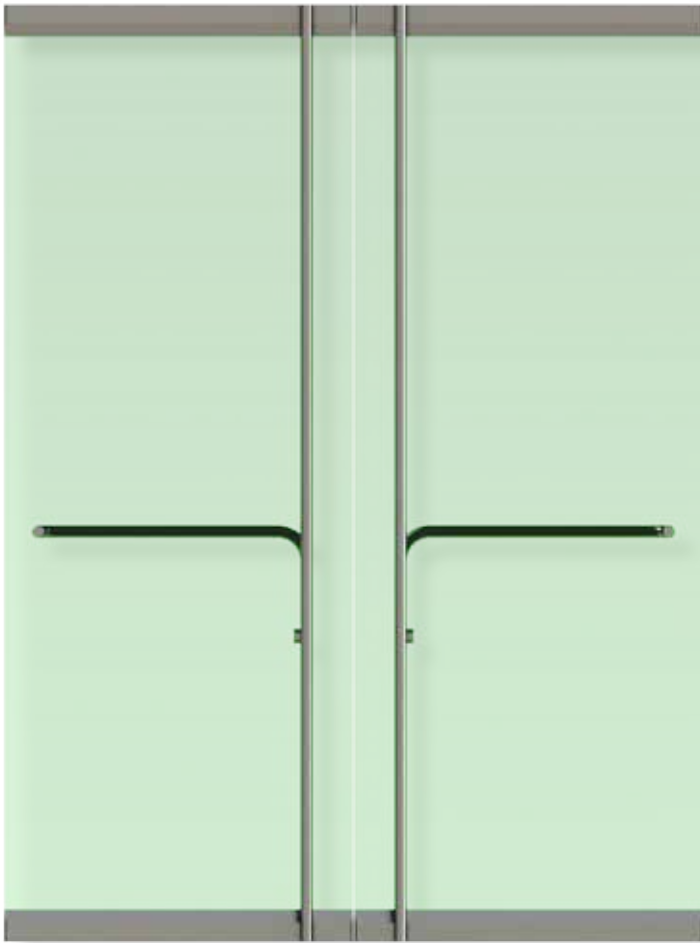

PL110F

Finish

- #4 brushed stainless steel
- #8 polished stainless steel
- Satin brass
- Polished brass
- us10b
- Custom painted

The following list of mortise cylinders will work with PRL Panics and Deadbolts

MFR.	NO.	NOMINAL LENGTH	CAM NO.
Schlage	20-001	1-1/8"	B502-191
Russwin	#0 1/2"	1-1/8"	#1
Corbin	5253	1-1/8"	#1
Sargent	41	1-1/8"	X13000
Best	1E64	1-1/8"	1EC4
Yale	1152	1-1/8"	1161 (std.)
Lori	218	1-1/8"	4400-00-3002

Removable core mortise cylinders and thumb-turns will function properly when fitted with one of the listed straight cams. Custom cylinder collars are available to accommodate cylinder lengths exceeding 1-1/8"

PRL GLASS SYSTEMS

PL110 PANIC HANDLE CONFIGURATIONS

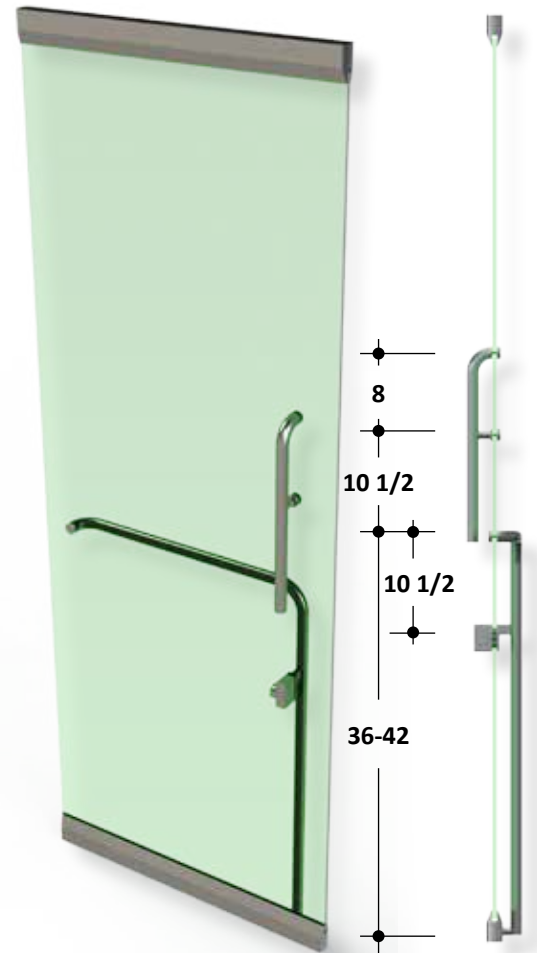
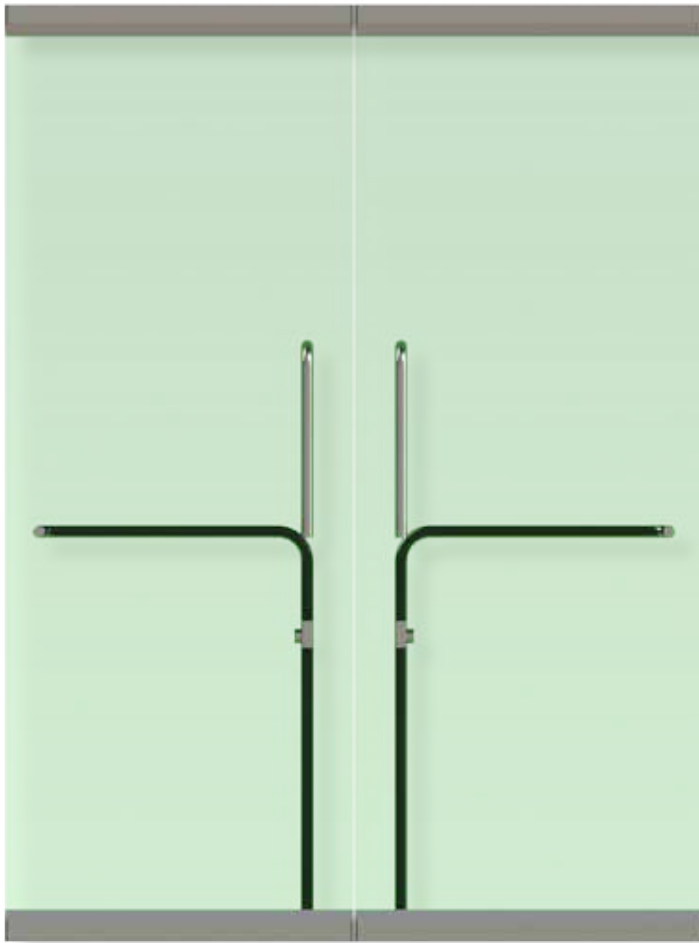

PL110G

Finish

- #4 brushed stainless steel
- #8 polished stainless steel
- Satin brass
- Polished brass
- us10b
- Custom painted

The following list of mortise cylinders will work with PRL Panics and Deadbolts

MFR.	NO.	NOMINAL LENGTH	CAM NO.
Schlage	20-001	1-1/8"	B502-191
Russwin	#0 1/2"	1-1/8"	#1
Corbin	5253	1-1/8"	#1
Sargent	41	1-1/8"	X13000
Best	1E64	1-1/8"	1EC4
Yale	1152	1-1/8"	1161 (std.)
Lori	218	1-1/8"	4400-00-3002

Removable core mortise cylinders and thumb-turns will function properly when fitted with one of the listed straight cams. Custom cylinder collars are available to accommodate cylinder lengths exceeding 1-1/8"

PRL GLASS SYSTEMS

PL110 PANIC HANDLE CONFIGURATIONS

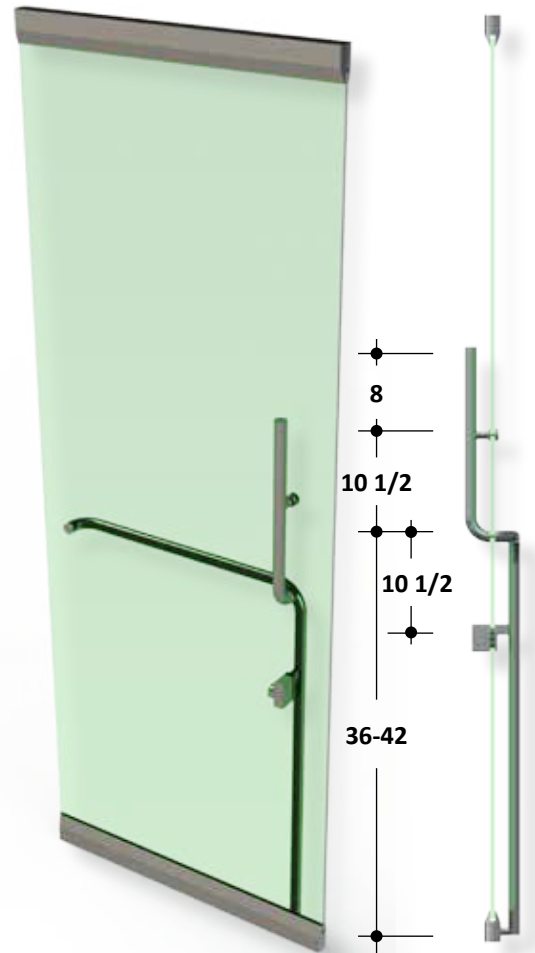
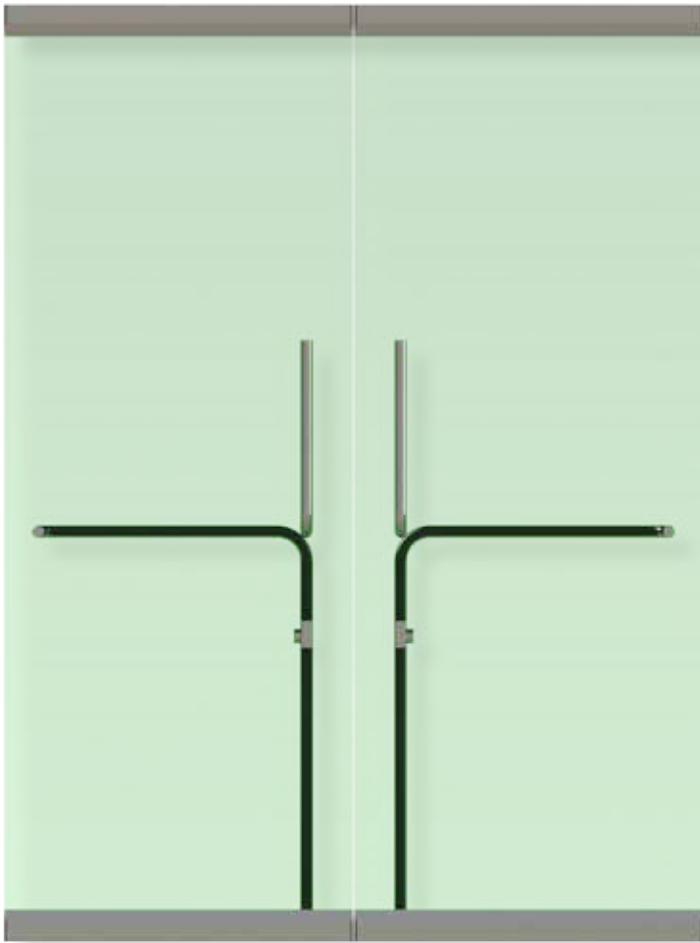

PL110H

Finish

- #4 brushed stainless steel
- #8 polished stainless steel
- Satin brass
- Polished brass
- us10b
- Custom painted

The following list of mortise cylinders will work with PRL Panics and Deadbolts

MFR.	NO.	NOMINAL LENGTH	CAM NO.
Schlage	20-001	1-1/8"	B502-191
Russwin	#0 1/2"	1-1/8"	#1
Corbin	5253	1-1/8"	#1
Sargent	41	1-1/8"	X13000
Best	1E64	1-1/8"	1EC4
Yale	1152	1-1/8"	1161 (std.)
Lori	218	1-1/8"	4400-00-3002

Removable core mortise cylinders and thumb-turns will function properly when fitted with one of the listed straight cams. Custom cylinder collars are available to accommodate cylinder lengths exceeding 1-1/8"

PRL GLASS SYSTEMS

PL110 PANIC HANDLE CONFIGURATIONS

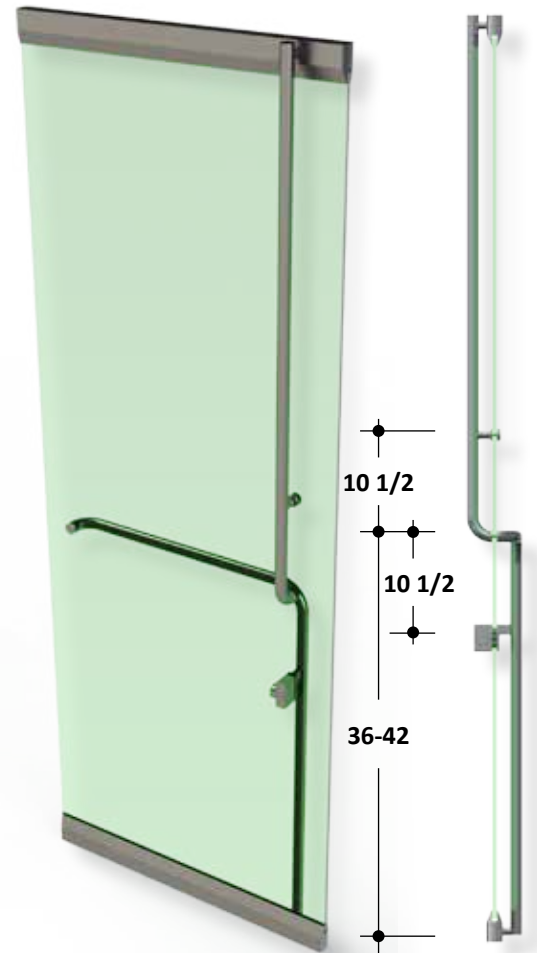
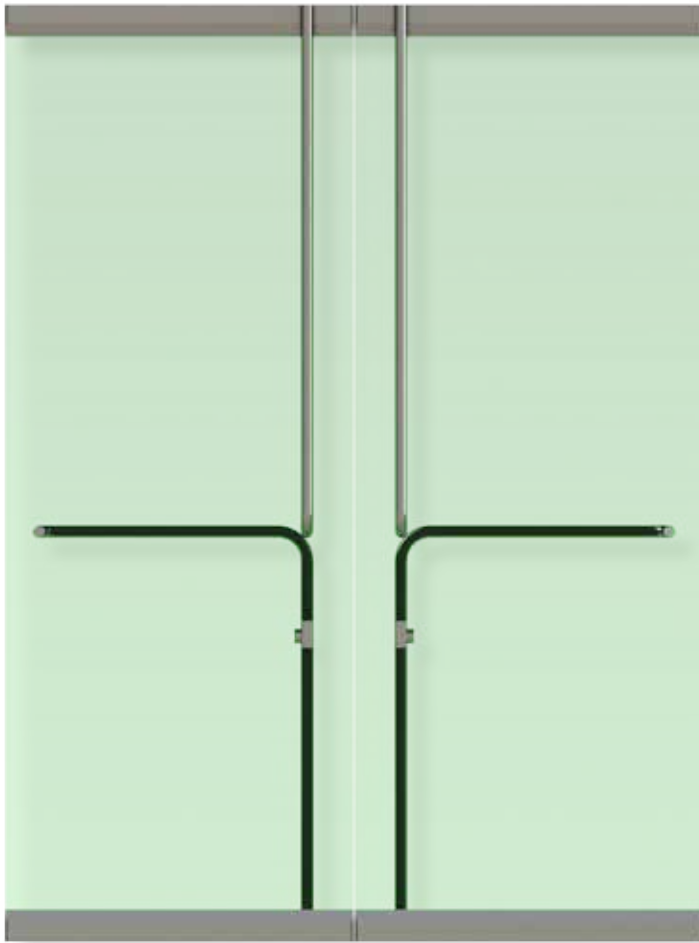

PL110J

Finish

- #4 brushed stainless steel
- #8 polished stainless steel
- Satin brass
- Polished brass
- us10b
- Custom painted

The following list of mortise cylinders will work with PRL Panics and Deadbolts

MFR.	NO.	NOMINAL LENGTH	CAM NO.
Schlage	20-001	1-1/8"	B502-191
Russwin	#0 1/2"	1-1/8"	#1
Corbin	5253	1-1/8"	#1
Sargent	41	1-1/8"	X13000
Best	1E64	1-1/8"	1EC4
Yale	1152	1-1/8"	1161 (std.)
Lori	218	1-1/8"	4400-00-3002

Removable core mortise cylinders and thumb-turns will function properly when fitted with one of the listed straight cams. Custom cylinder collars are available to accommodate cylinder lengths exceeding 1-1/8"

PRL GLASS SYSTEMS

PL110 PANIC HANDLE CONFIGURATIONS

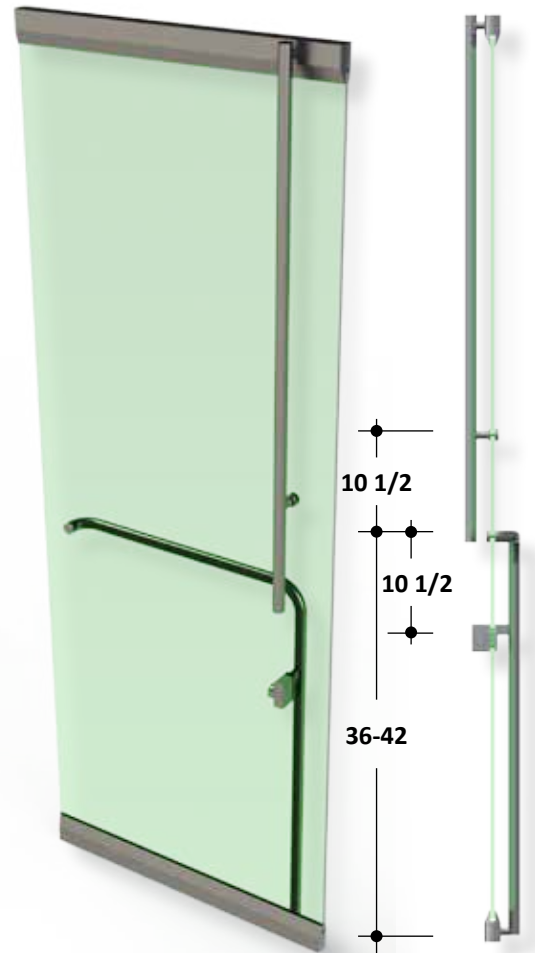
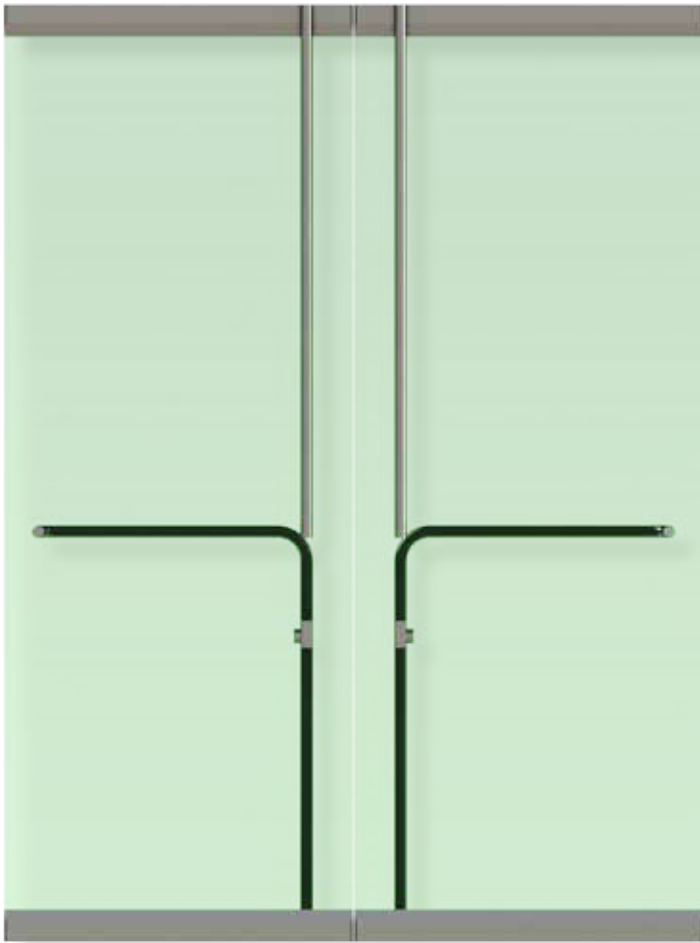

PL110JS

Finish

- #4 brushed stainless steel
- #8 polished stainless steel
- Satin brass
- Polished brass
- us10b
- Custom painted

The following list of mortise cylinders will work with PRL Panics and Deadbolts

MFR.	NO.	NOMINAL LENGTH	CAM NO.
Schlage	20-001	1-1/8"	B502-191
Russwin	#0 1/2"	1-1/8"	#1
Corbin	5253	1-1/8"	#1
Sargent	41	1-1/8"	X13000
Best	1E64	1-1/8"	1EC4
Yale	1152	1-1/8"	1161 (std.)
Lori	218	1-1/8"	4400-00-3002

Removable core mortise cylinders and thumb-turns will function properly when fitted with one of the listed straight cams. Custom cylinder collars are available to accommodate cylinder lengths exceeding 1-1/8"

PRL GLASS SYSTEMS

PL110 PANIC HANDLE CONFIGURATIONS

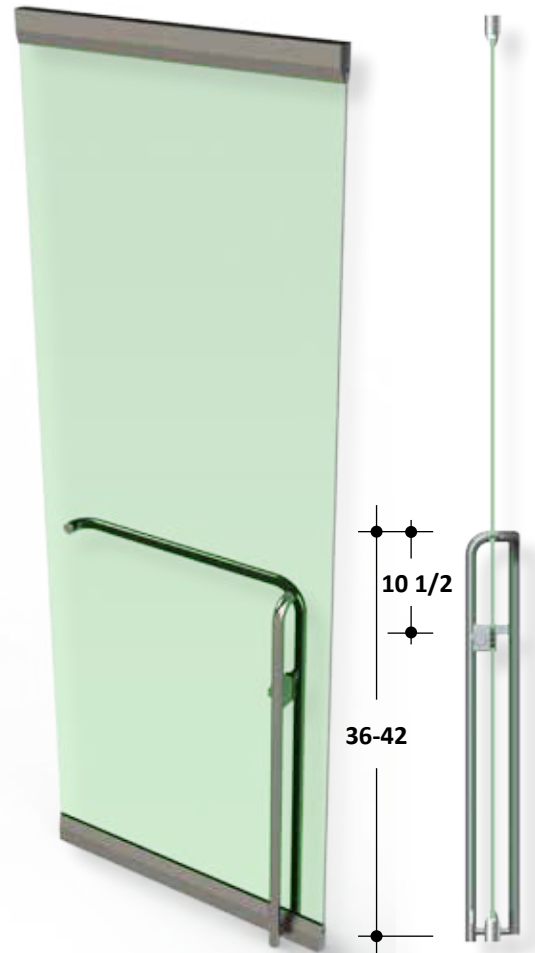
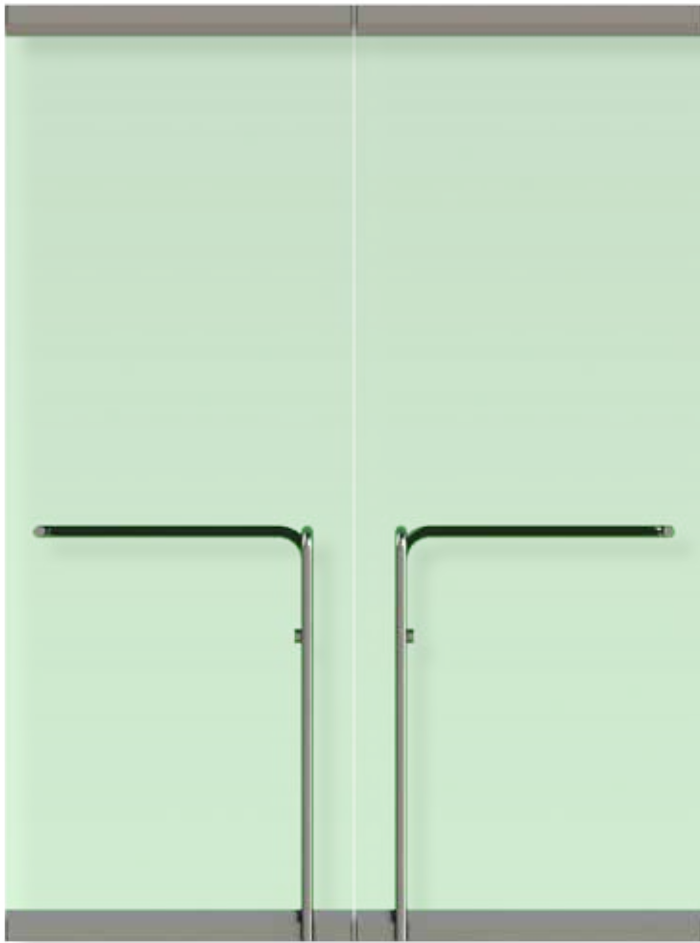

PL110K

Finish

- #4 brushed stainless steel
- #8 polished stainless steel
- Satin brass
- Polished brass
- us10b
- Custom painted

The following list of mortise cylinders will work with PRL Panics and Deadbolts

MFR.	NO.	NOMINAL LENGTH	CAM NO.
Schlage	20-001	1-1/8"	B502-191
Russwin	#0 1/2"	1-1/8"	#1
Corbin	5253	1-1/8"	#1
Sargent	41	1-1/8"	X13000
Best	1E64	1-1/8"	1EC4
Yale	1152	1-1/8"	1161 (std.)
Lori	218	1-1/8"	4400-00-3002

Removable core mortise cylinders and thumb-turns will function properly when fitted with one of the listed straight cams. Custom cylinder collars are available to accommodate cylinder lengths exceeding 1-1/8"

PRL GLASS SYSTEMS

PL110 PANIC HANDLE CONFIGURATIONS

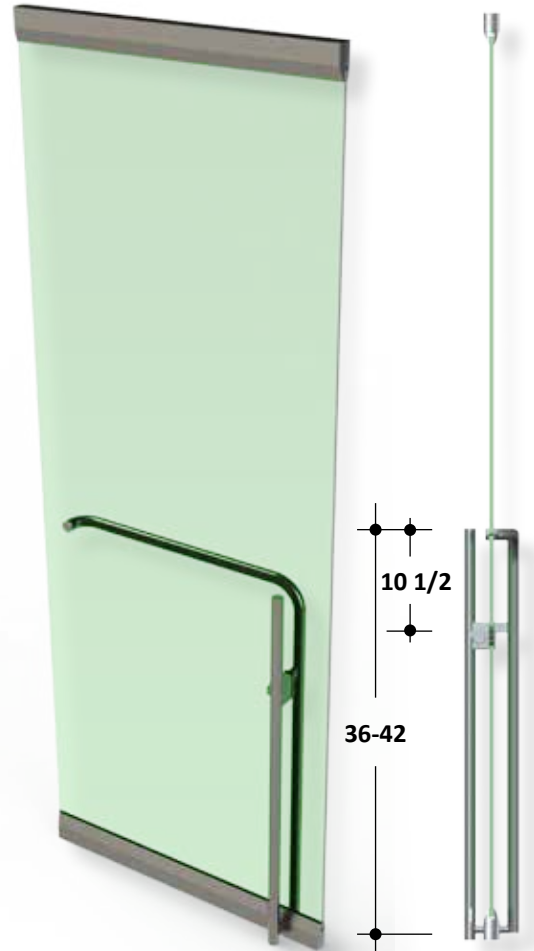
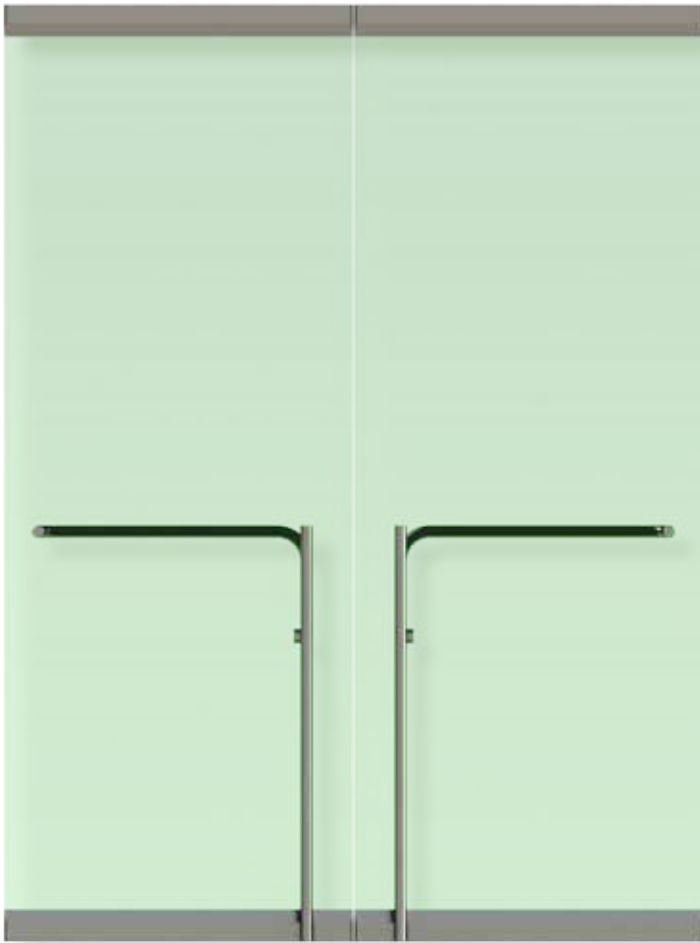

PL110KS

Finish

- #4 brushed stainless steel
- #8 polished stainless steel
- Satin brass
- Polished brass
- us10b
- Custom painted

The following list of mortise cylinders will work with PRL Panics and Deadbolts

MFR.	NO.	NOMINAL LENGTH	CAM NO.
Schlage	20-001	1-1/8"	B502-191
Russwin	#0 1/2"	1-1/8"	#1
Corbin	5253	1-1/8"	#1
Sargent	41	1-1/8"	X13000
Best	1E64	1-1/8"	1EC4
Yale	1152	1-1/8"	1161 (std.)
Lori	218	1-1/8"	4400-00-3002

Removable core mortise cylinders and thumb-turns will function properly when fitted with one of the listed straight cams. Custom cylinder collars are available to accommodate cylinder lengths exceeding 1-1/8"

PRL GLASS SYSTEMS

PL110 PANIC HANDLE CONFIGURATIONS

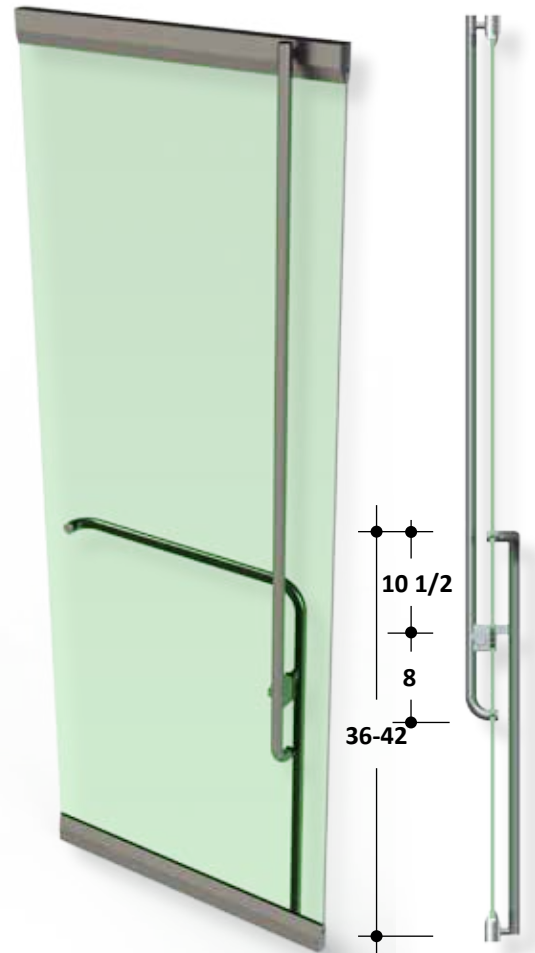
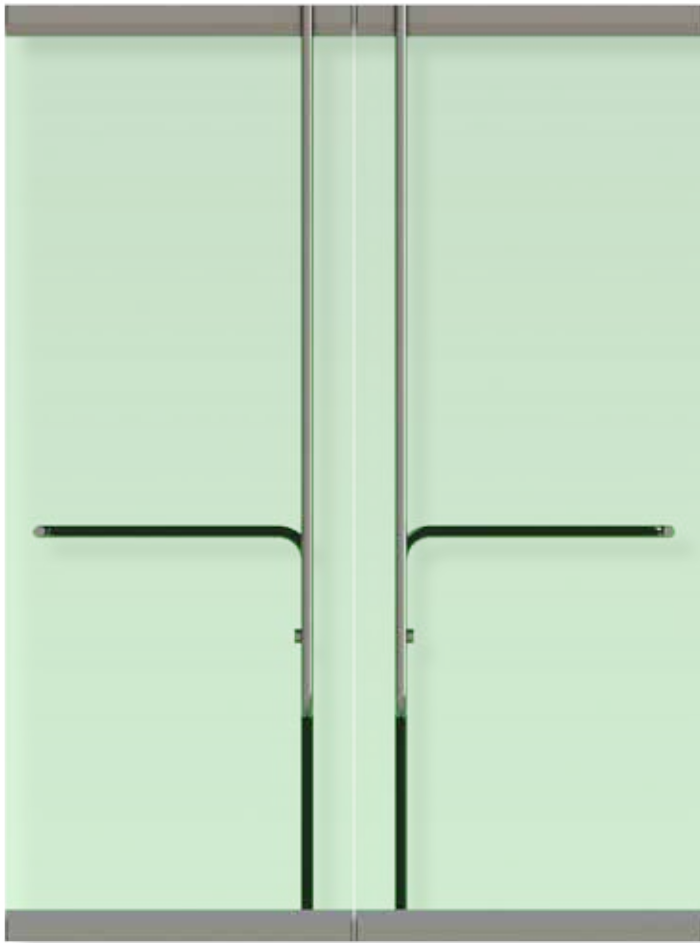

PL110L

Finish

- #4 brushed stainless steel
- #8 polished stainless steel
- Satin brass
- Polished brass
- us10b
- Custom painted

The following list of mortise cylinders will work with PRL Panics and Deadbolts

MFR.	NO.	NOMINAL LENGTH	CAM NO.
Schlage	20-001	1-1/8"	B502-191
Russwin	#0 1/2"	1-1/8"	#1
Corbin	5253	1-1/8"	#1
Sargent	41	1-1/8"	X13000
Best	1E64	1-1/8"	1EC4
Yale	1152	1-1/8"	1161 (std.)
Lori	218	1-1/8"	4400-00-3002

Removable core mortise cylinders and thumb-turns will function properly when fitted with one of the listed straight cams. Custom cylinder collars are available to accommodate cylinder lengths exceeding 1-1/8"

PRL GLASS SYSTEMS

PL110 PANIC HANDLE CONFIGURATIONS

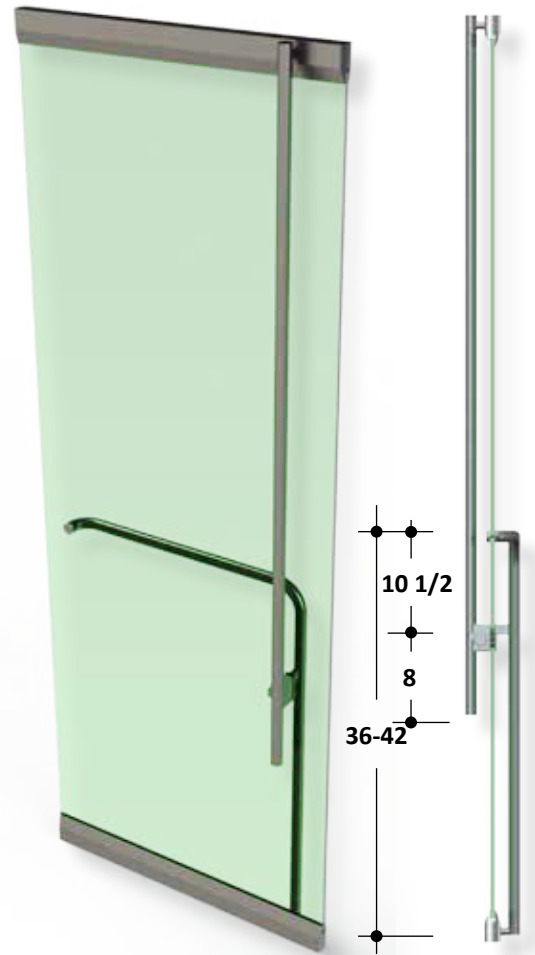
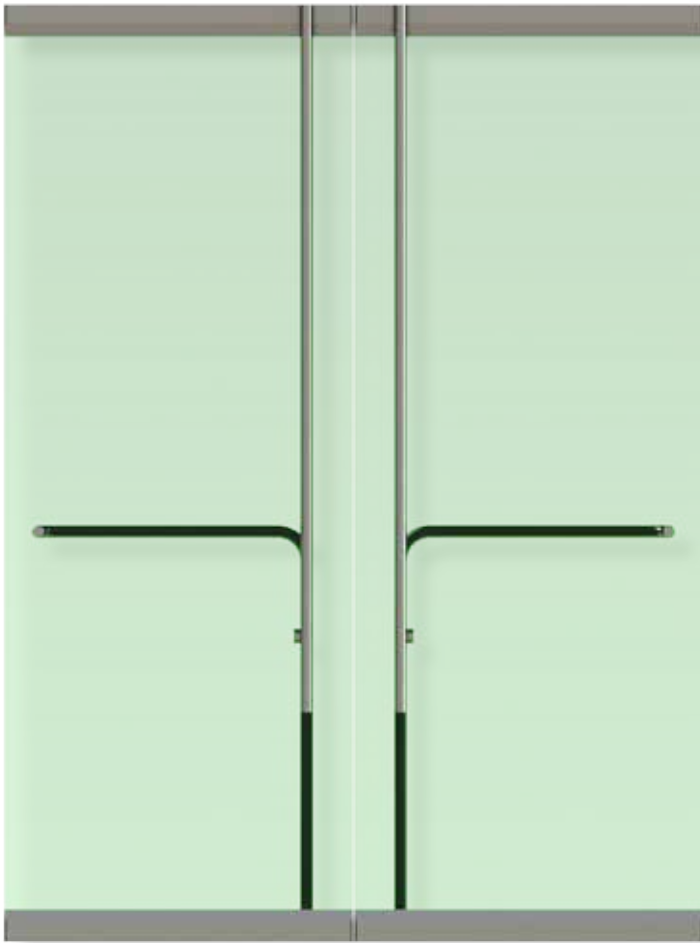

PL110LS

Finish

- #4 brushed stainless steel
- #8 polished stainless steel
- Satin brass
- Polished brass
- us10b
- Custom painted

The following list of mortise cylinders will work with PRL Panics and Deadbolts

MFR.	NO.	NOMINAL LENGTH	CAM NO.
Schlage	20-001	1-1/8"	B502-191
Russwin	#0 1/2"	1-1/8"	#1
Corbin	5253	1-1/8"	#1
Sargent	41	1-1/8"	X13000
Best	1E64	1-1/8"	1EC4
Yale	1152	1-1/8"	1161 (std.)
Lori	218	1-1/8"	4400-00-3002

Removable core mortise cylinders and thumb-turns will function properly when fitted with one of the listed straight cams. Custom cylinder collars are available to accommodate cylinder lengths exceeding 1-1/8"

PRL GLASS SYSTEMS

PL110 PANIC HANDLE CONFIGURATIONS

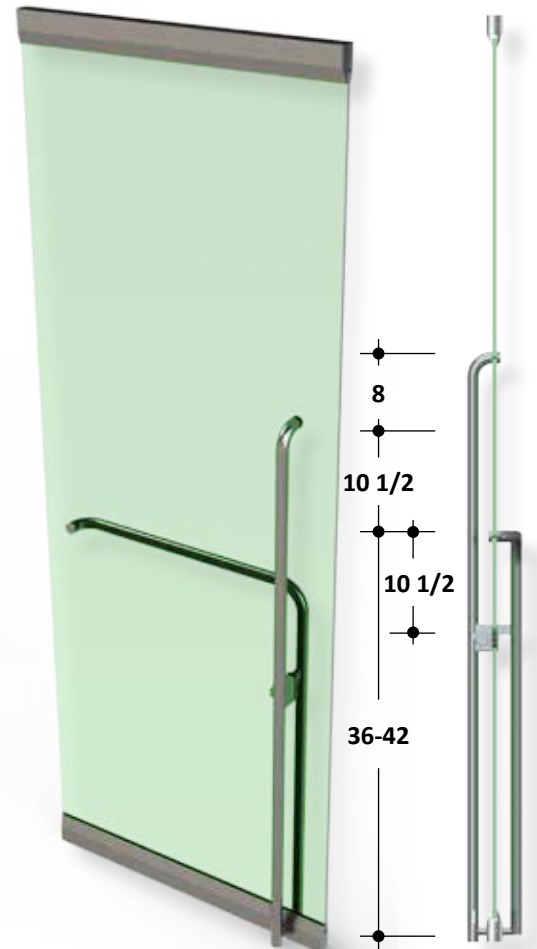
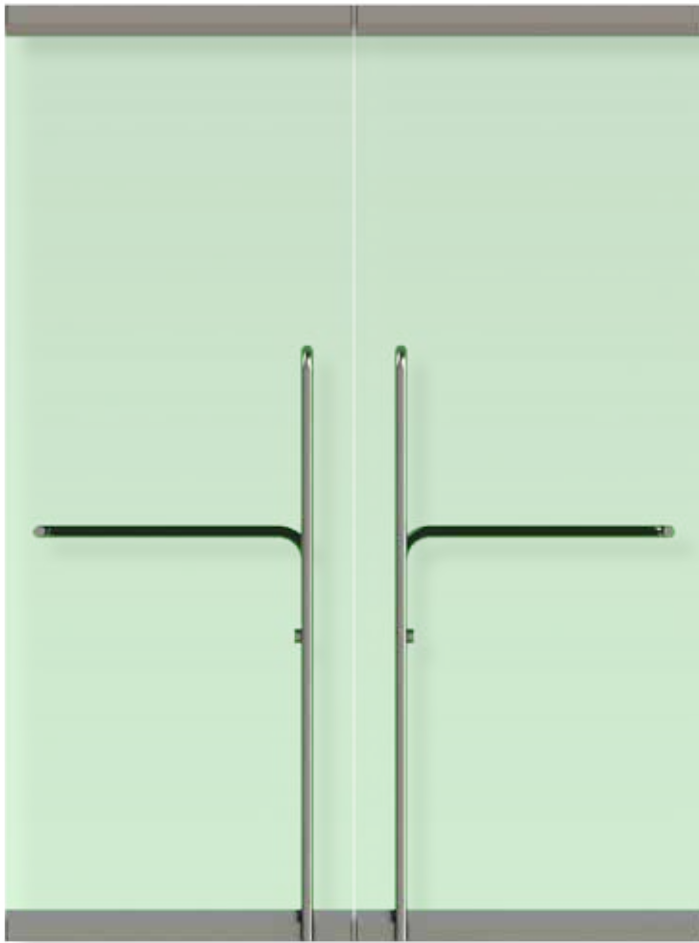

PL110M

Finish

- #4 brushed stainless steel
- #8 polished stainless steel
- Satin brass
- Polished brass
- us10b
- Custom painted

The following list of mortise cylinders will work with PRL Panics and Deadbolts

MFR.	NO.	NOMINAL LENGTH	CAM NO.
Schlage	20-001	1-1/8"	B502-191
Russwin	#0 1/2"	1-1/8"	#1
Corbin	5253	1-1/8"	#1
Sargent	41	1-1/8"	X13000
Best	1E64	1-1/8"	1EC4
Yale	1152	1-1/8"	1161 (std.)
Lori	218	1-1/8"	4400-00-3002

Removable core mortise cylinders and thumb-turns will function properly when fitted with one of the listed straight cams. Custom cylinder collars are available to accommodate cylinder lengths exceeding 1-1/8"

PRL GLASS SYSTEMS

PL110 PANIC HANDLE CONFIGURATIONS

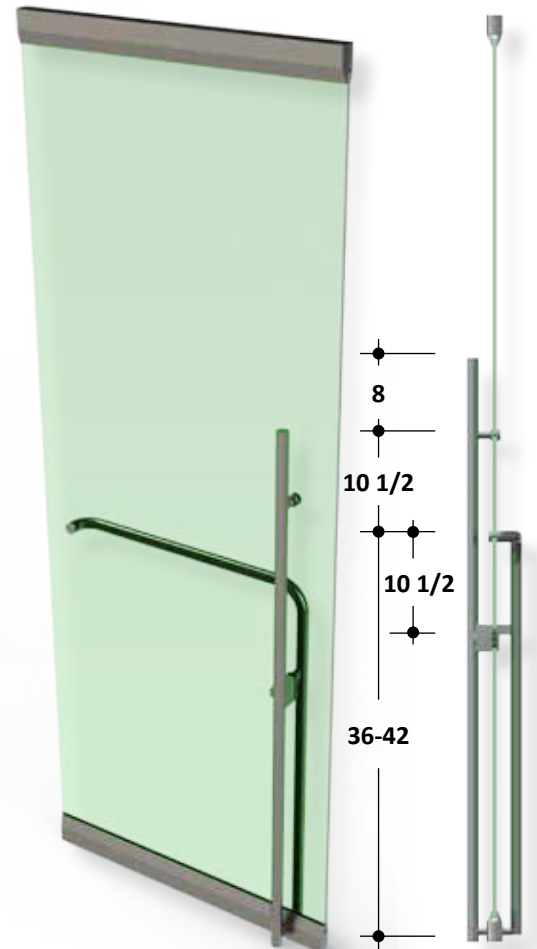
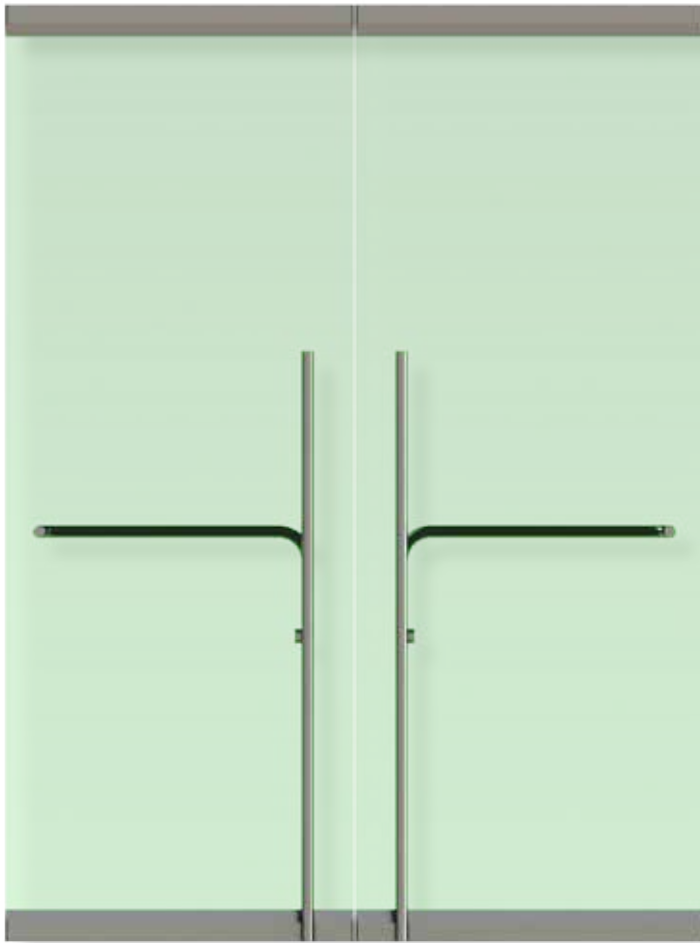

PL110MS

Finish

- #4 brushed stainless steel
- #8 polished stainless steel
- Satin brass
- Polished brass
- us10b
- Custom painted

The following list of mortise cylinders will work with PRL Panics and Deadbolts

MFR.	NO.	NOMINAL LENGTH	CAM NO.
Schlage	20-001	1-1/8"	B502-191
Russwin	#0 1/2"	1-1/8"	#1
Corbin	5253	1-1/8"	#1
Sargent	41	1-1/8"	X13000
Best	1E64	1-1/8"	1EC4
Yale	1152	1-1/8"	1161 (std.)
Lori	218	1-1/8"	4400-00-3002

Removable core mortise cylinders and thumb-turns will function properly when fitted with one of the listed straight cams. Custom cylinder collars are available to accommodate cylinder lengths exceeding 1-1/8"

PRL GLASS SYSTEMS

PL110 PANIC HANDLE CONFIGURATIONS

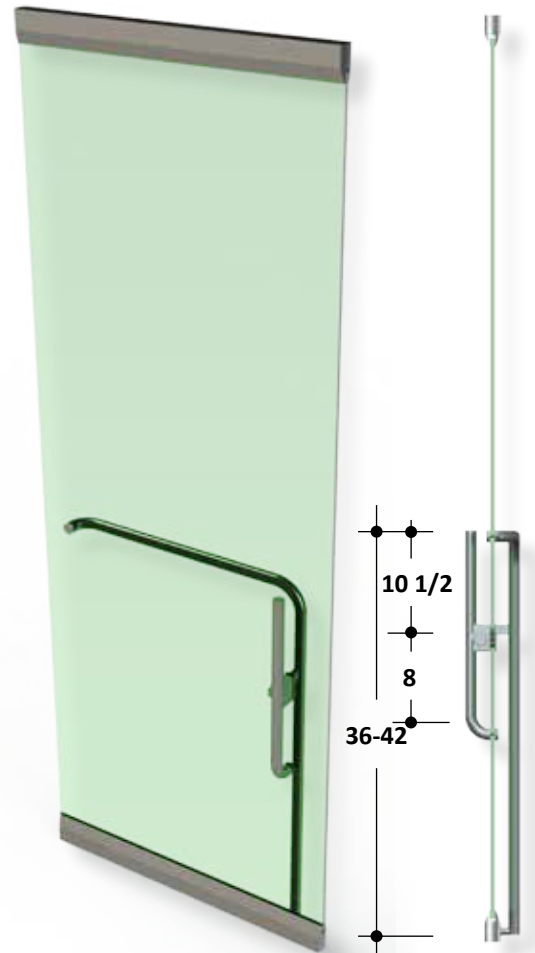
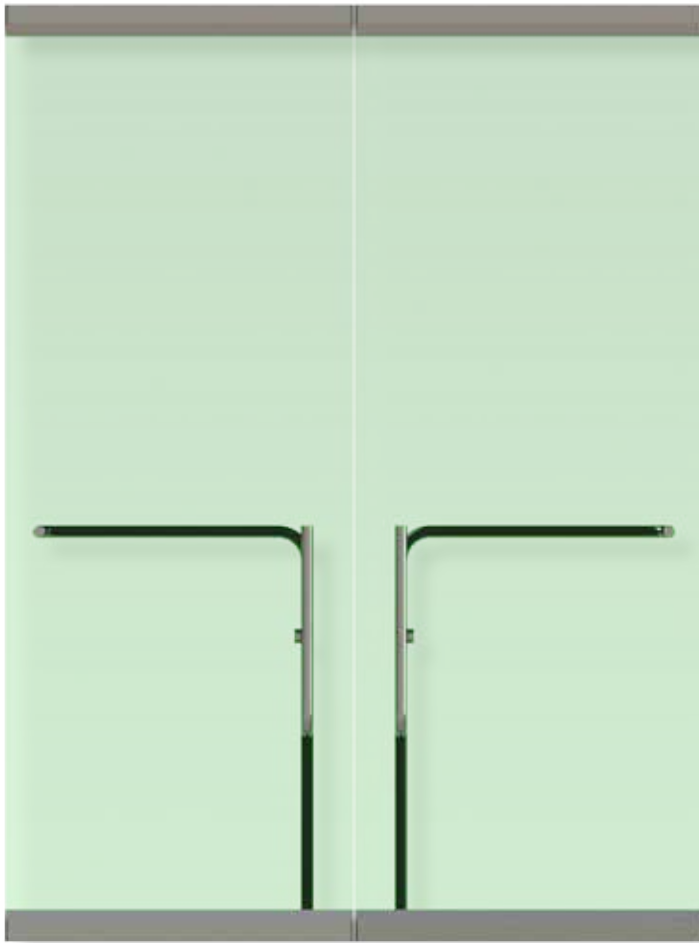

PL110N

Finish

- #4 brushed stainless steel
- #8 polished stainless steel
- Satin brass
- Polished brass
- us10b
- Custom painted

The following list of mortise cylinders will work with PRL Panics and Deadbolts

MFR.	NO.	NOMINAL LENGTH	CAM NO.
Schlage	20-001	1-1/8"	B502-191
Russwin	#0 1/2"	1-1/8"	#1
Corbin	5253	1-1/8"	#1
Sargent	41	1-1/8"	X13000
Best	1E64	1-1/8"	1EC4
Yale	1152	1-1/8"	1161 (std.)
Lori	218	1-1/8"	4400-00-3002

Removable core mortise cylinders and thumb-turns will function properly when fitted with one of the listed straight cams. Custom cylinder collars are available to accommodate cylinder lengths exceeding 1-1/8"

PRL GLASS SYSTEMS

PL110 PANIC HANDLE CONFIGURATIONS

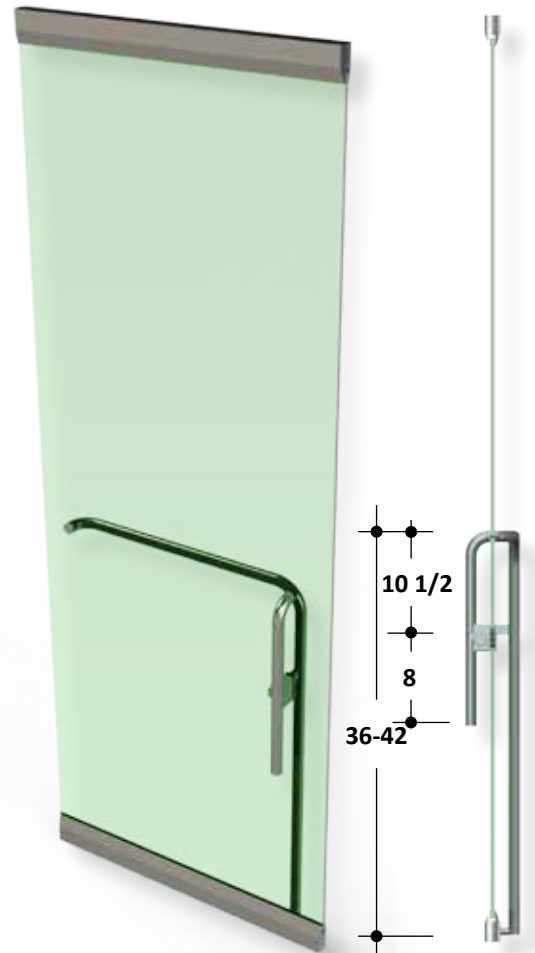
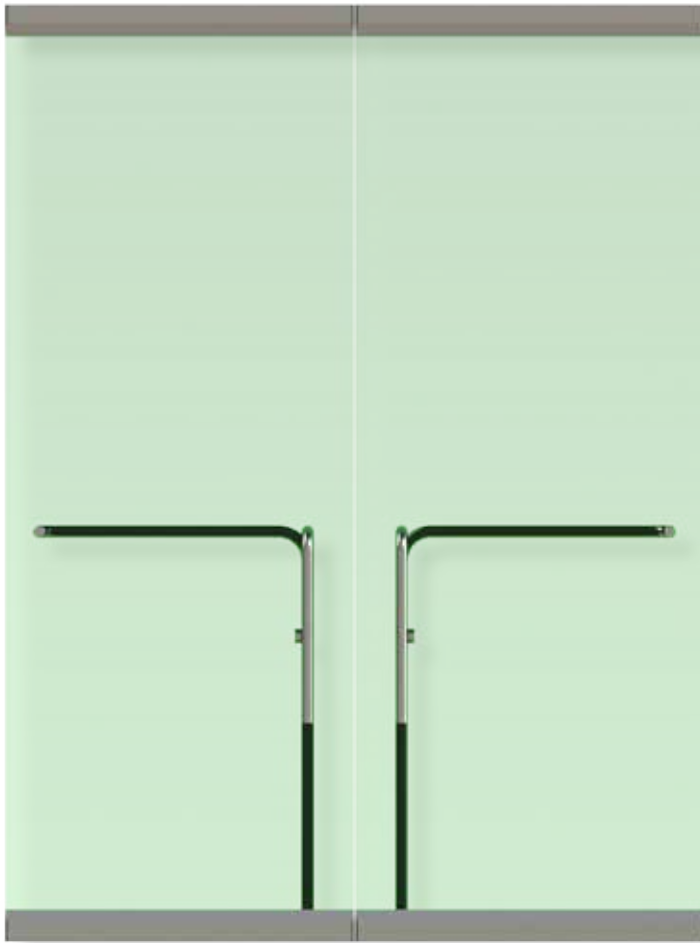

PL110P

Finish

- #4 brushed stainless steel
- #8 polished stainless steel
- Satin brass
- Polished brass
- us10b
- Custom painted

The following list of mortise cylinders will work with PRL Panics and Deadbolts

MFR.	NO.	NOMINAL LENGTH	CAM NO.
Schlage	20-001	1-1/8"	B502-191
Russwin	#0 1/2"	1-1/8"	#1
Corbin	5253	1-1/8"	#1
Sargent	41	1-1/8"	X13000
Best	1E64	1-1/8"	1EC4
Yale	1152	1-1/8"	1161 (std.)
Lori	218	1-1/8"	4400-00-3002

Removable core mortise cylinders and thumb-turns will function properly when fitted with one of the listed straight cams. Custom cylinder collars are available to accommodate cylinder lengths exceeding 1-1/8"

PRL GLASS SYSTEMS

PL110 PANIC HANDLE CONFIGURATIONS

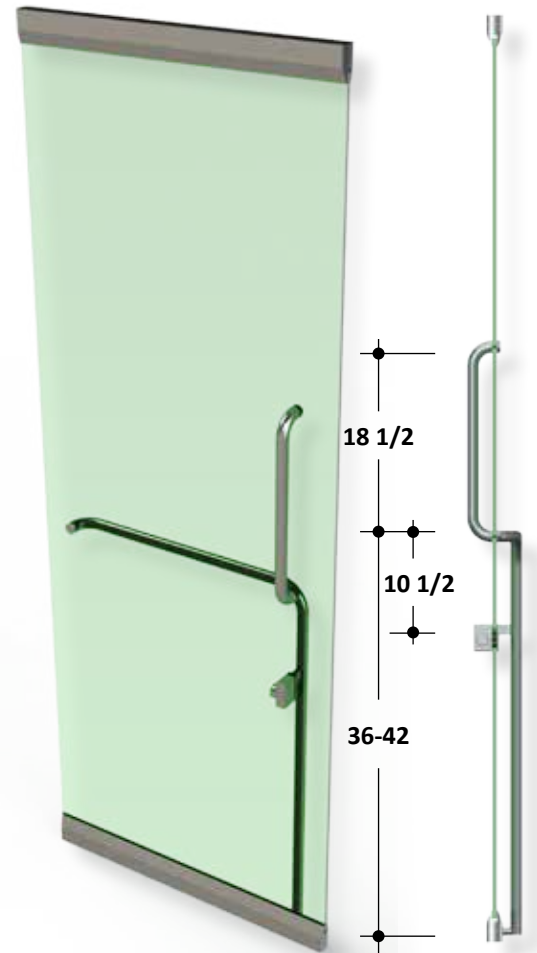
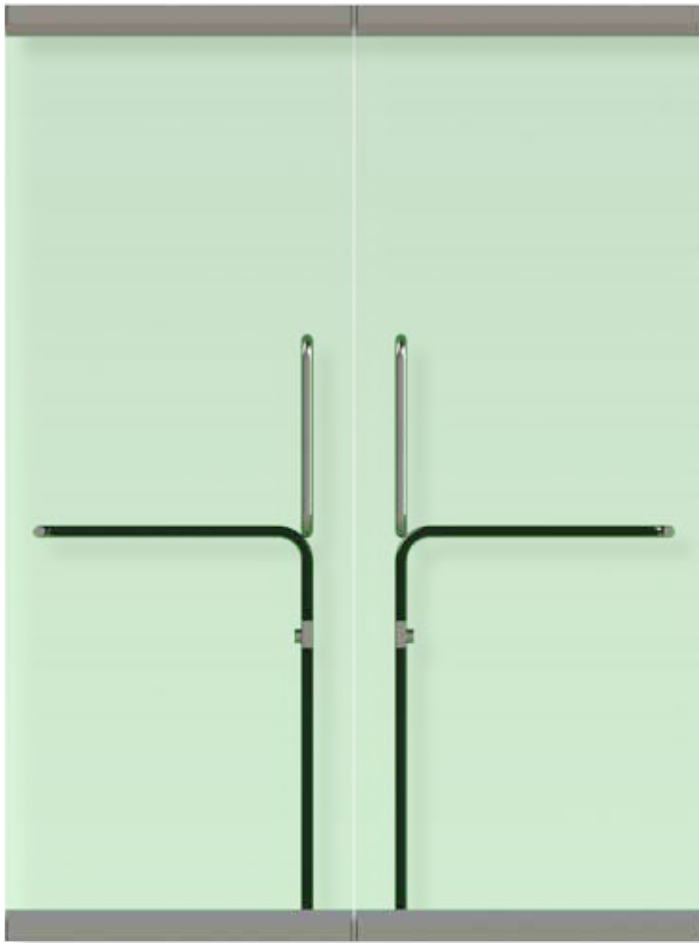

PL110X

Finish

- #4 brushed stainless steel
- #8 polished stainless steel
- Satin brass
- Polished brass
- us10b
- Custom painted

The following list of mortise cylinders will work with PRL Panics and Deadbolts

MFR.	NO.	NOMINAL LENGTH	CAM NO.
Schlage	20-001	1-1/8"	B502-191
Russwin	#0 1/2"	1-1/8"	#1
Corbin	5253	1-1/8"	#1
Sargent	41	1-1/8"	X13000
Best	1E64	1-1/8"	1EC4
Yale	1152	1-1/8"	1161 (std.)
Lori	218	1-1/8"	4400-00-3002

Removable core mortise cylinders and thumb-turns will function properly when fitted with one of the listed straight cams. Custom cylinder collars are available to accommodate cylinder lengths exceeding 1-1/8"

PRL GLASS SYSTEMS

PL110 PANIC HANDLE CONFIGURATIONS

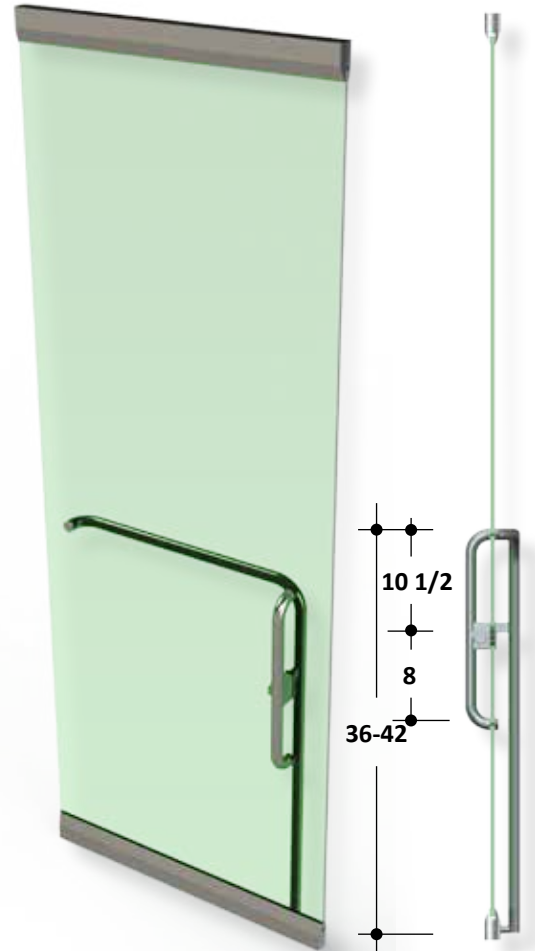
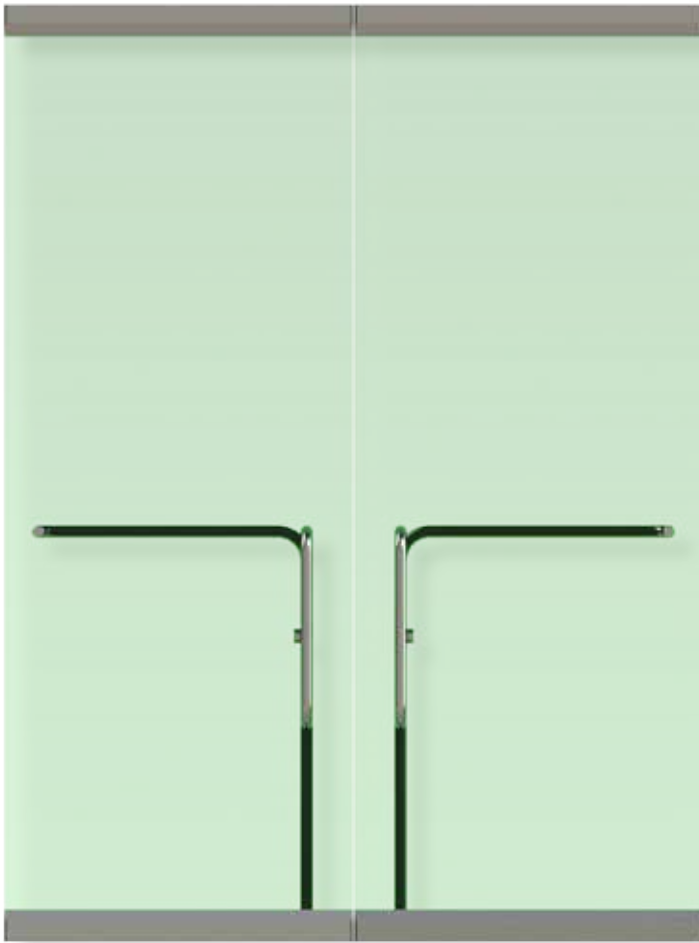

PL110Y

Finish

- #4 brushed stainless steel
- #8 polished stainless steel
- Satin brass
- Polished brass
- us10b
- Custom painted

The following list of mortise cylinders will work with PRL Panics and Deadbolts

MFR.	NO.	NOMINAL LENGTH	CAM NO.
Schlage	20-001	1-1/8"	B502-191
Russwin	#0 1/2"	1-1/8"	#1
Corbin	5253	1-1/8"	#1
Sargent	41	1-1/8"	X13000
Best	1E64	1-1/8"	1EC4
Yale	1152	1-1/8"	1161 (std.)
Lori	218	1-1/8"	4400-00-3002

Removable core mortise cylinders and thumb-turns will function properly when fitted with one of the listed straight cams. Custom cylinder collars are available to accommodate cylinder lengths exceeding 1-1/8"

PRL GLASS SYSTEMS

PL110 PANIC HANDLE CONFIGURATIONS

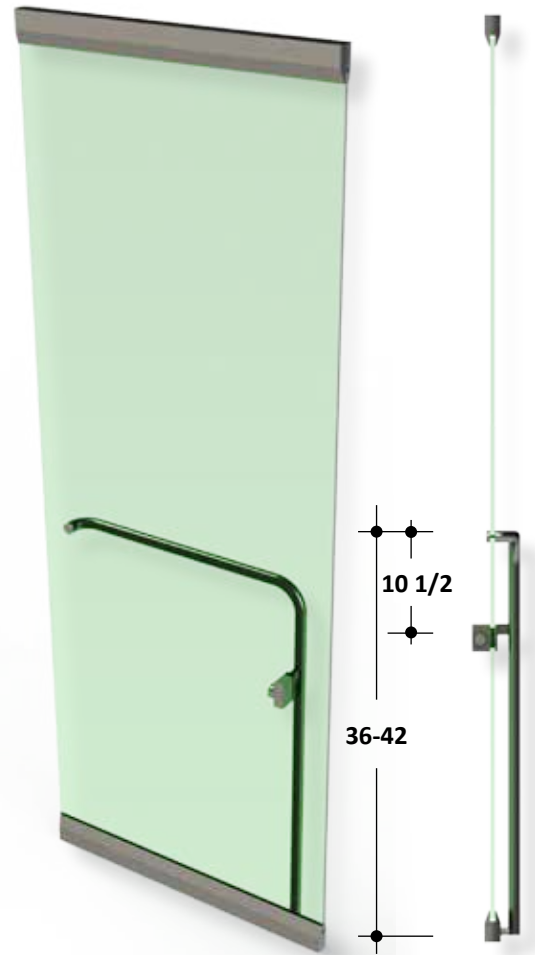
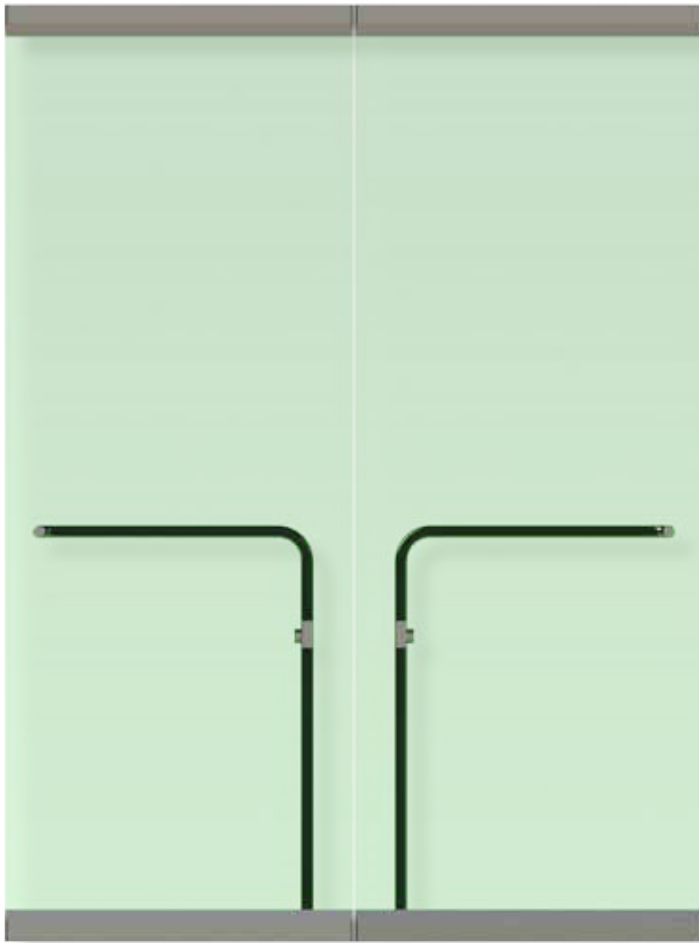

PL110Z

Finish

- #4 brushed stainless steel
- #8 polished stainless steel
- Satin brass
- Polished brass
- us10b
- Custom painted

The following list of mortise cylinders will work with PRL Panics and Deadbolts

MFR.	NO.	NOMINAL LENGTH	CAM NO.
Schlage	20-001	1-1/8"	B502-191
Russwin	#0 1/2"	1-1/8"	#1
Corbin	5253	1-1/8"	#1
Sargent	41	1-1/8"	X13000
Best	1E64	1-1/8"	1EC4
Yale	1152	1-1/8"	1161 (std.)
Lori	218	1-1/8"	4400-00-3002

Removable core mortise cylinders and thumb-turns will function properly when fitted with one of the listed straight cams. Custom cylinder collars are available to accommodate cylinder lengths exceeding 1-1/8"

PRL GLASS SYSTEMS

PL110 PANIC HANDLE CONFIGURATIONS



PL110A

Finish

- #4 brushed stainless steel
- #8 polished stainless steel
- Satin brass
- Polished brass
- us10b
- Custom painted

The following list of mortise cylinders will work with PRL Panics and Deadbolts

MFR.	NO.	NOMINAL LENGTH	CAM NO.
Schlage	20-001	1-1/8"	B502-191
Russwin	#0 1/2"	1-1/8"	#1
Corbin	5253	1-1/8"	#1
Sargent	41	1-1/8"	X13000
Best	1E64	1-1/8"	1EC4
Yale	1152	1-1/8"	1161 (std.)
Lori	218	1-1/8"	4400-00-3002

Removable core mortise cylinders and thumb-turns will function properly when fitted with one of the listed straight cams. Custom cylinder collars are available to accommodate cylinder lengths exceeding 1-1/8"

PRL GLASS SYSTEMS

PL110 PANIC HANDLE CONFIGURATIONS

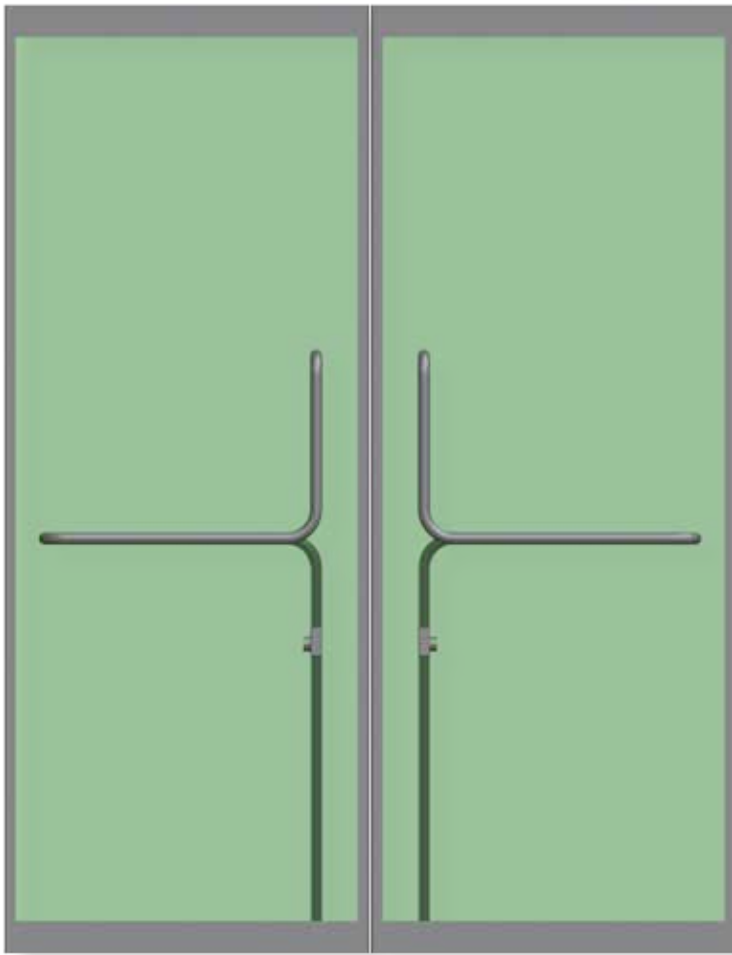

PL110B

Finish

- #4 brushed stainless steel
- #8 polished stainless steel
- Satin brass
- Polished brass
- us10b
- Custom painted

The following list of mortise cylinders will work with PRL Panics and Deadbolts

MFR.	NO.	NOMINAL LENGTH	CAM NO.
Schlage	20-001	1-1/8"	B502-191
Russwin	#0 1/2"	1-1/8"	#1
Corbin	5253	1-1/8"	#1
Sargent	41	1-1/8"	X13000
Best	1E64	1-1/8"	1EC4
Yale	1152	1-1/8"	1161 (std.)
Lori	218	1-1/8"	4400-00-3002

Removable core mortise cylinders and thumb-turns will function properly when fitted with one of the listed straight cams. Custom cylinder collars are available to accommodate cylinder lengths exceeding 1-1/8"

PRL GLASS SYSTEMS

PL110 PANIC HANDLE CONFIGURATIONS

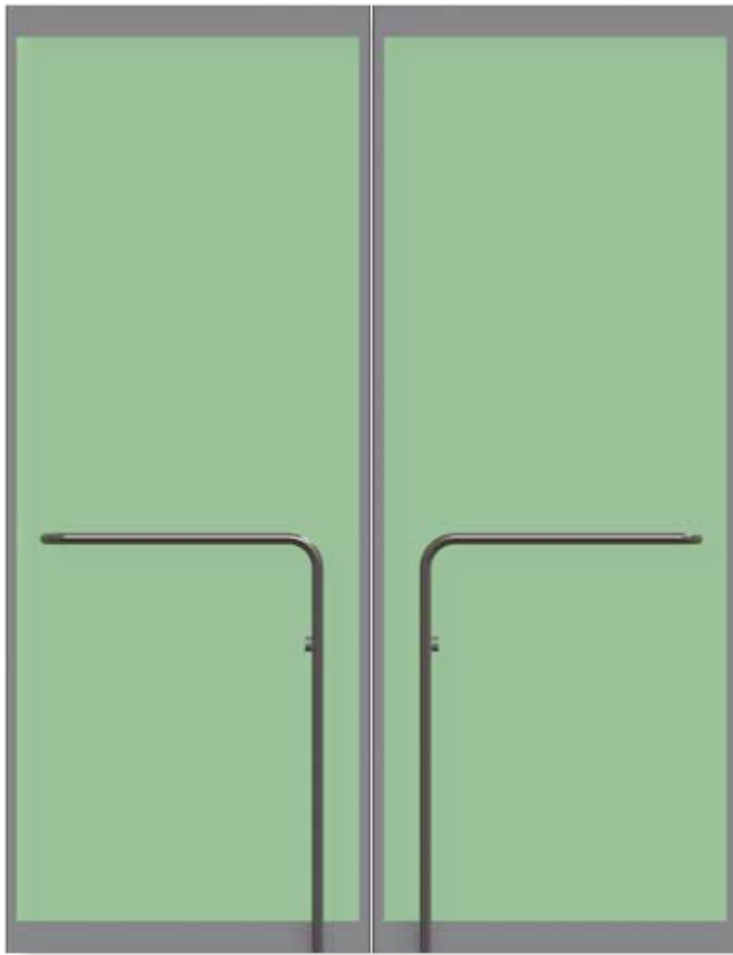

PL110C

Finish

- #4 brushed stainless steel
- #8 polished stainless steel
- Satin brass
- Polished brass
- us10b
- Custom painted

The following list of mortise cylinders will work with PRL Panics and Deadbolts

MFR.	NO.	NOMINAL LENGTH	CAM NO.
Schlage	20-001	1-1/8"	B502-191
Russwin	#0 1/2"	1-1/8"	#1
Corbin	5253	1-1/8"	#1
Sargent	41	1-1/8"	X13000
Best	1E64	1-1/8"	1EC4
Yale	1152	1-1/8"	1161 (std.)
Lori	218	1-1/8"	4400-00-3002

Removable core mortise cylinders and thumb-turns will function properly when fitted with one of the listed straight cams. Custom cylinder collars are available to accommodate cylinder lengths exceeding 1-1/8"

PRL GLASS SYSTEMS

PL110 PANIC HANDLE CONFIGURATIONS

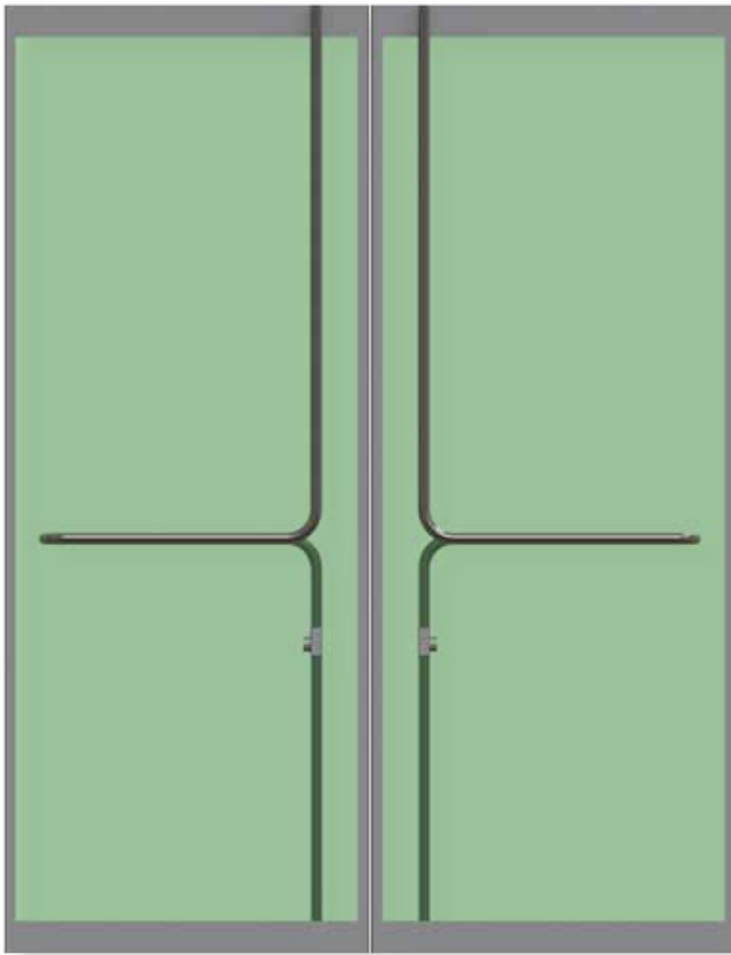

PL110D

Finish

- #4 brushed stainless steel
- #8 polished stainless steel
- Satin brass
- Polished brass
- us10b
- Custom painted

The following list of mortise cylinders will work with PRL Panics and Deadbolts

MFR.	NO.	NOMINAL LENGTH	CAM NO.
Schlage	20-001	1-1/8"	B502-191
Russwin	#0 1/2"	1-1/8"	#1
Corbin	5253	1-1/8"	#1
Sargent	41	1-1/8"	X13000
Best	1E64	1-1/8"	1EC4
Yale	1152	1-1/8"	1161 (std.)
Lori	218	1-1/8"	4400-00-3002

Removable core mortise cylinders and thumb-turns will function properly when fitted with one of the listed straight cams. Custom cylinder collars are available to accommodate cylinder lengths exceeding 1-1/8"

PRL GLASS SYSTEMS

PL110 PANIC HANDLE CONFIGURATIONS

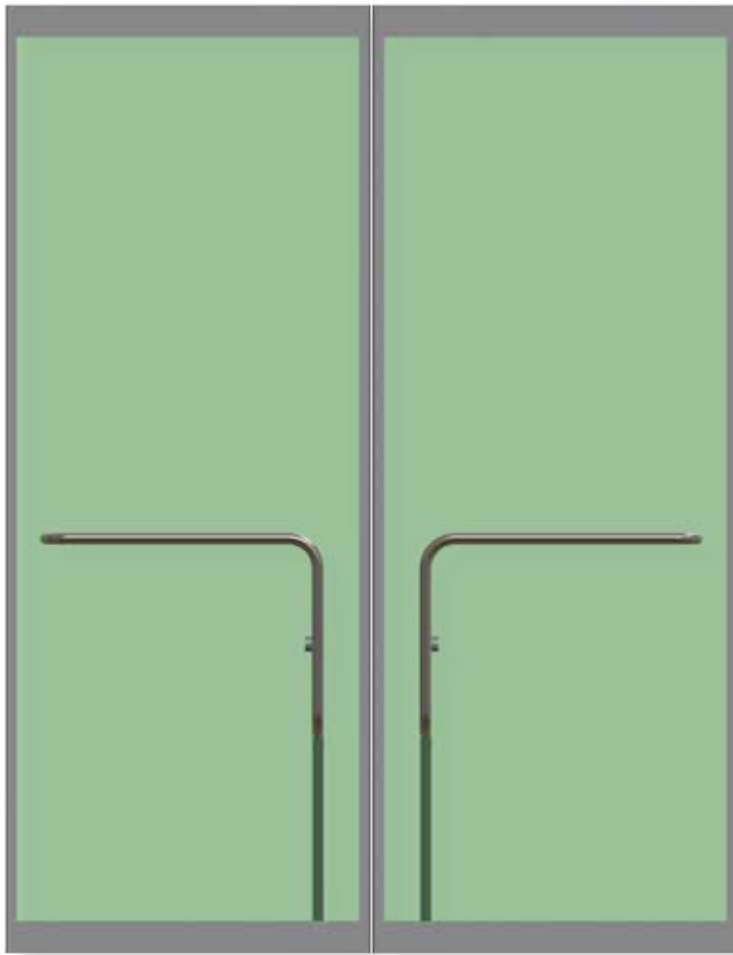

PL110E

Finish

- #4 brushed stainless steel
- #8 polished stainless steel
- Satin brass
- Polished brass
- us10b
- Custom painted

The following list of mortise cylinders will work with PRL Panics and Deadbolts

MFR.	NO.	NOMINAL LENGTH	CAM NO.
Schlage	20-001	1-1/8"	B502-191
Russwin	#0 1/2"	1-1/8"	#1
Corbin	5253	1-1/8"	#1
Sargent	41	1-1/8"	X13000
Best	1E64	1-1/8"	1EC4
Yale	1152	1-1/8"	1161 (std.)
Lori	218	1-1/8"	4400-00-3002

Removable core mortise cylinders and thumb-turns will function properly when fitted with one of the listed straight cams. Custom cylinder collars are available to accommodate cylinder lengths exceeding 1-1/8"

PRL GLASS SYSTEMS

PL110 PANIC HANDLE CONFIGURATIONS

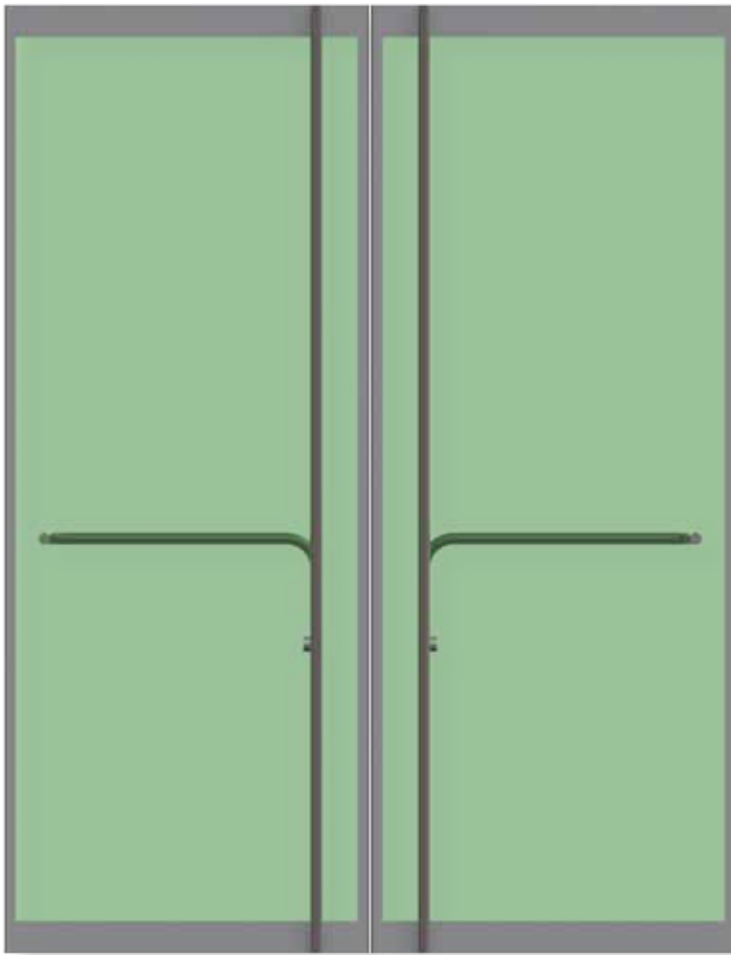

PL110F

Finish

- #4 brushed stainless steel
- #8 polished stainless steel
- Satin brass
- Polished brass
- us10b
- Custom painted

The following list of mortise cylinders will work with PRL Panics and Deadbolts

MFR.	NO.	NOMINAL LENGTH	CAM NO.
Schlage	20-001	1-1/8"	B502-191
Russwin	#0 1/2"	1-1/8"	#1
Corbin	5253	1-1/8"	#1
Sargent	41	1-1/8"	X13000
Best	1E64	1-1/8"	1EC4
Yale	1152	1-1/8"	1161 (std.)
Lori	218	1-1/8"	4400-00-3002

Removable core mortise cylinders and thumb-turns will function properly when fitted with one of the listed straight cams. Custom cylinder collars are available to accommodate cylinder lengths exceeding 1-1/8"

PRL GLASS SYSTEMS

PL110 PANIC HANDLE CONFIGURATIONS

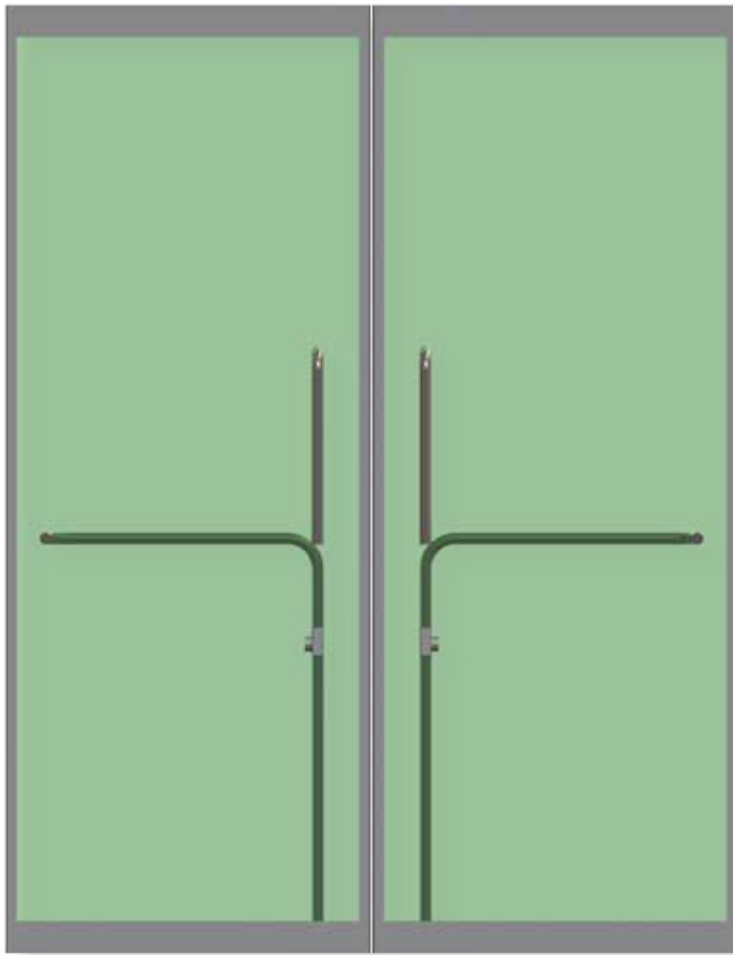

PL110G

Finish

- #4 brushed stainless steel
- #8 polished stainless steel
- Satin brass
- Polished brass
- us10b
- Custom painted

The following list of mortise cylinders will work with PRL Panics and Deadbolts

MFR.	NO.	NOMINAL LENGTH	CAM NO.
Schlage	20-001	1-1/8"	B502-191
Russwin	#0 1/2"	1-1/8"	#1
Corbin	5253	1-1/8"	#1
Sargent	41	1-1/8"	X13000
Best	1E64	1-1/8"	1EC4
Yale	1152	1-1/8"	1161 (std.)
Lori	218	1-1/8"	4400-00-3002

Removable core mortise cylinders and thumb-turns will function properly when fitted with one of the listed straight cams. Custom cylinder collars are available to accommodate cylinder lengths exceeding 1-1/8"

PRL GLASS SYSTEMS

PL110 PANIC HANDLE CONFIGURATIONS

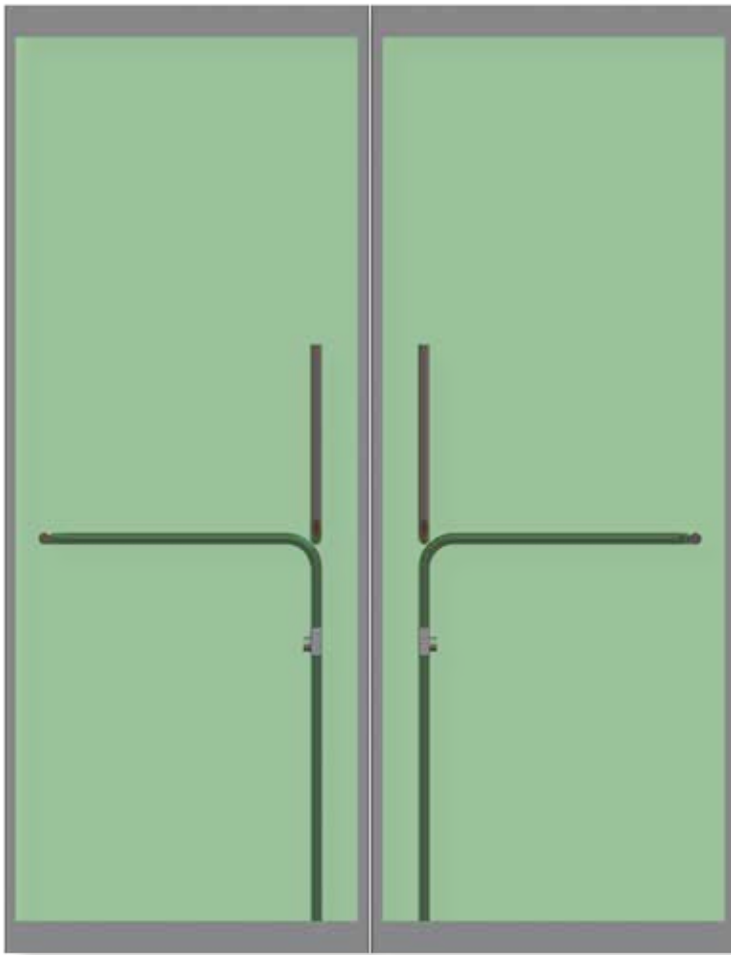

PL110H

Finish

- #4 brushed stainless steel
- #8 polished stainless steel
- Satin brass
- Polished brass
- us10b
- Custom painted

The following list of mortise cylinders will work with PRL Panics and Deadbolts

MFR.	NO.	NOMINAL LENGTH	CAM NO.
Schlage	20-001	1-1/8"	B502-191
Russwin	#0 1/2"	1-1/8"	#1
Corbin	5253	1-1/8"	#1
Sargent	41	1-1/8"	X13000
Best	1E64	1-1/8"	1EC4
Yale	1152	1-1/8"	1161 (std.)
Lori	218	1-1/8"	4400-00-3002

Removable core mortise cylinders and thumb-turns will function properly when fitted with one of the listed straight cams. Custom cylinder collars are available to accommodate cylinder lengths exceeding 1-1/8"

PRL GLASS SYSTEMS

PL110 PANIC HANDLE CONFIGURATIONS

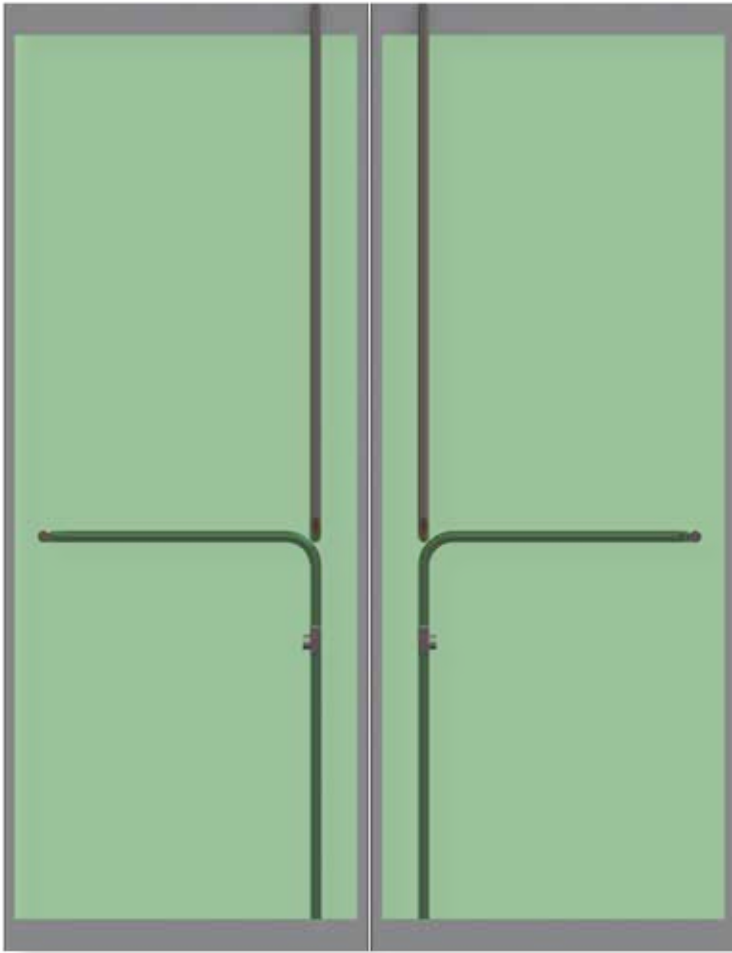

PL110J

Finish

- #4 brushed stainless steel
- #8 polished stainless steel
- Satin brass
- Polished brass
- us10b
- Custom painted

The following list of mortise cylinders will work with PRL Panics and Deadbolts

MFR.	NO.	NOMINAL LENGTH	CAM NO.
Schlage	20-001	1-1/8"	B502-191
Russwin	#0 1/2"	1-1/8"	#1
Corbin	5253	1-1/8"	#1
Sargent	41	1-1/8"	X13000
Best	1E64	1-1/8"	1EC4
Yale	1152	1-1/8"	1161 (std.)
Lori	218	1-1/8"	4400-00-3002

Removable core mortise cylinders and thumb-turns will function properly when fitted with one of the listed straight cams. Custom cylinder collars are available to accommodate cylinder lengths exceeding 1-1/8"

PRL GLASS SYSTEMS

PL110 PANIC HANDLE CONFIGURATIONS

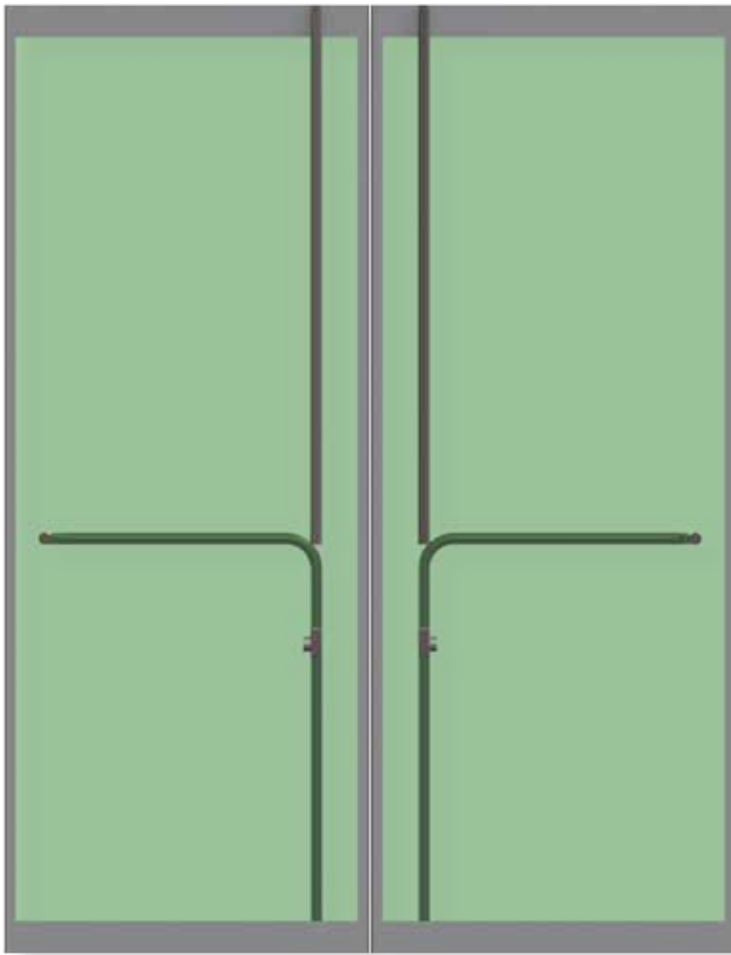

PL110JS

Finish

- #4 brushed stainless steel
- #8 polished stainless steel
- Satin brass
- Polished brass
- us10b
- Custom painted

The following list of mortise cylinders will work with PRL Panics and Deadbolts

MFR.	NO.	NOMINAL LENGTH	CAM NO.
Schlage	20-001	1-1/8"	B502-191
Russwin	#0 1/2"	1-1/8"	#1
Corbin	5253	1-1/8"	#1
Sargent	41	1-1/8"	X13000
Best	1E64	1-1/8"	1EC4
Yale	1152	1-1/8"	1161 (std.)
Lori	218	1-1/8"	4400-00-3002

Removable core mortise cylinders and thumb-turns will function properly when fitted with one of the listed straight cams. Custom cylinder collars are available to accommodate cylinder lengths exceeding 1-1/8"

PRL GLASS SYSTEMS

PL110 PANIC HANDLE CONFIGURATIONS

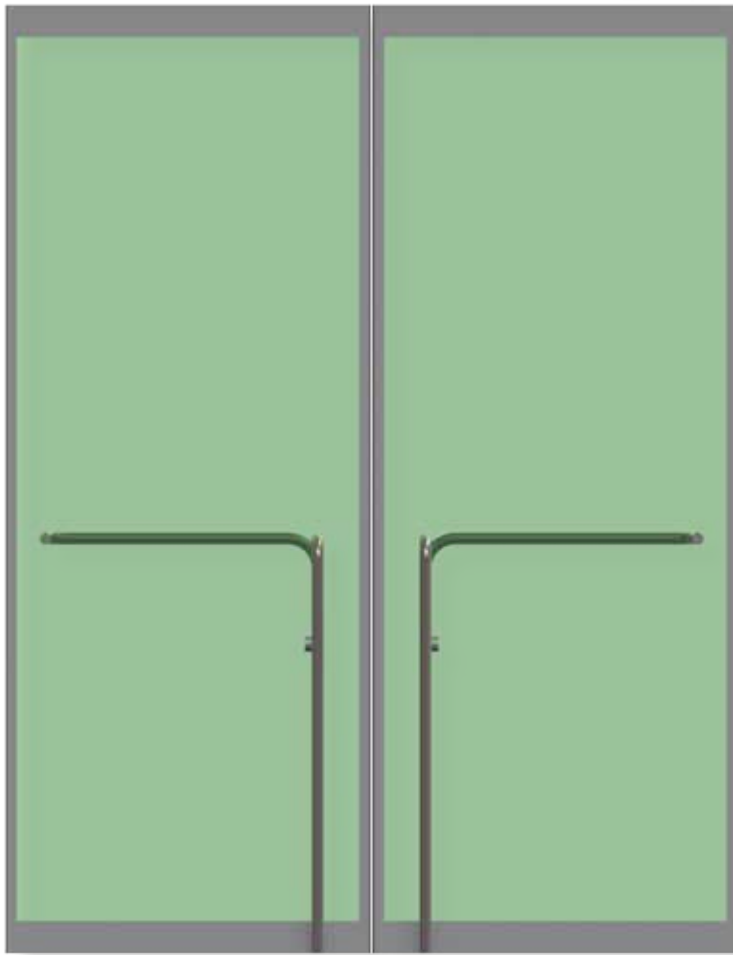

PL110K

Finish

- #4 brushed stainless steel
- #8 polished stainless steel
- Satin brass
- Polished brass
- us10b
- Custom painted

The following list of mortise cylinders will work with PRL Panics and Deadbolts

MFR.	NO.	NOMINAL LENGTH	CAM NO.
Schlage	20-001	1-1/8"	B502-191
Russwin	#0 1/2"	1-1/8"	#1
Corbin	5253	1-1/8"	#1
Sargent	41	1-1/8"	X13000
Best	1E64	1-1/8"	1EC4
Yale	1152	1-1/8"	1161 (std.)
Lori	218	1-1/8"	4400-00-3002

Removable core mortise cylinders and thumb-turns will function properly when fitted with one of the listed straight cams. Custom cylinder collars are available to accommodate cylinder lengths exceeding 1-1/8"

PRL GLASS SYSTEMS

PL110 PANIC HANDLE CONFIGURATIONS

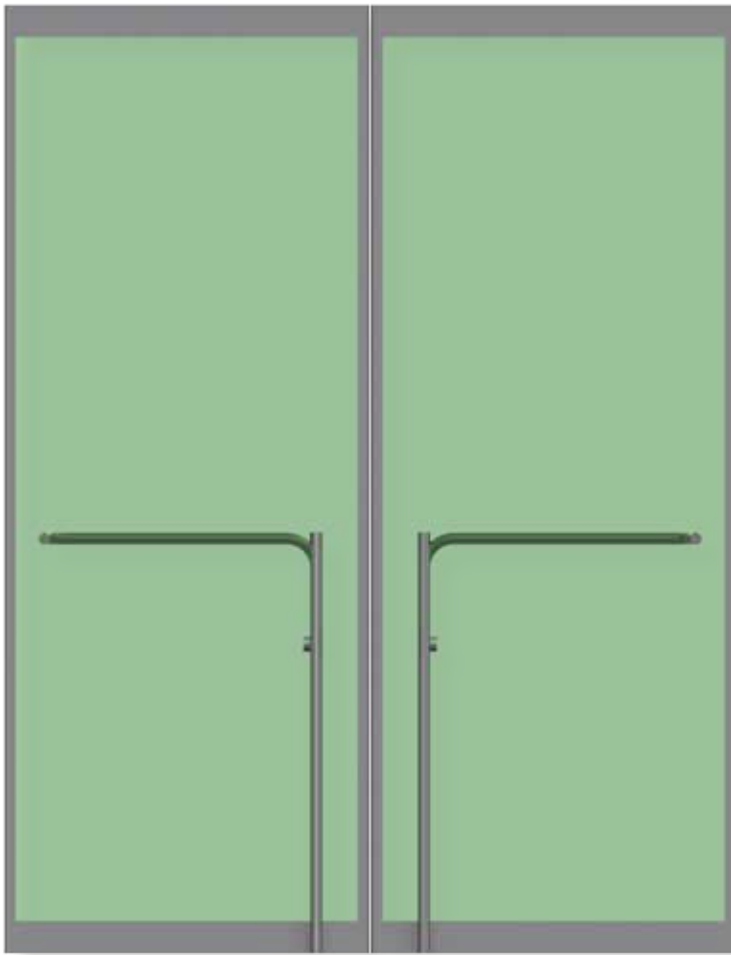

PL110KS

Finish

- #4 brushed stainless steel
- #8 polished stainless steel
- Satin brass
- Polished brass
- us10b
- Custom painted

The following list of mortise cylinders will work with PRL Panics and Deadbolts

MFR.	NO.	NOMINAL LENGTH	CAM NO.
Schlage	20-001	1-1/8"	B502-191
Russwin	#0 1/2"	1-1/8"	#1
Corbin	5253	1-1/8"	#1
Sargent	41	1-1/8"	X13000
Best	1E64	1-1/8"	1EC4
Yale	1152	1-1/8"	1161 (std.)
Lori	218	1-1/8"	4400-00-3002

Removable core mortise cylinders and thumb-turns will function properly when fitted with one of the listed straight cams. Custom cylinder collars are available to accommodate cylinder lengths exceeding 1-1/8"

PRL GLASS SYSTEMS

PL110 PANIC HANDLE CONFIGURATIONS

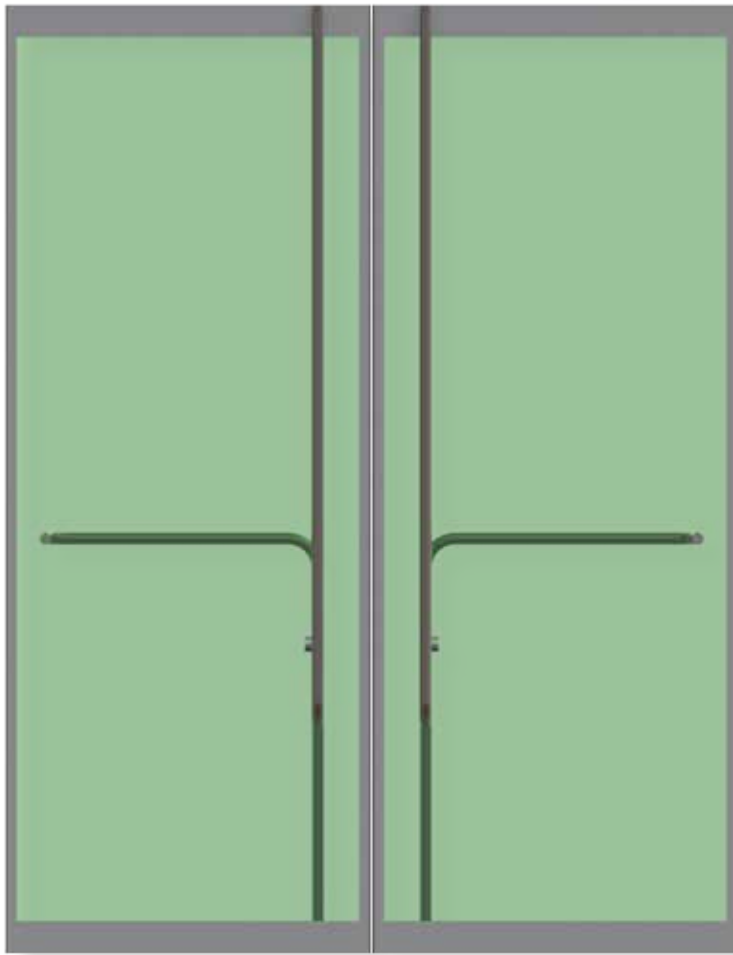

PL110L

Finish

- #4 brushed stainless steel
- #8 polished stainless steel
- Satin brass
- Polished brass
- us10b
- Custom painted

The following list of mortise cylinders will work with PRL Panics and Deadbolts

MFR.	NO.	NOMINAL LENGTH	CAM NO.
Schlage	20-001	1-1/8"	B502-191
Russwin	#0 1/2"	1-1/8"	#1
Corbin	5253	1-1/8"	#1
Sargent	41	1-1/8"	X13000
Best	1E64	1-1/8"	1EC4
Yale	1152	1-1/8"	1161 (std.)
Lori	218	1-1/8"	4400-00-3002

Removable core mortise cylinders and thumb-turns will function properly when fitted with one of the listed straight cams. Custom cylinder collars are available to accommodate cylinder lengths exceeding 1-1/8"

PRL GLASS SYSTEMS

PL110 PANIC HANDLE CONFIGURATIONS

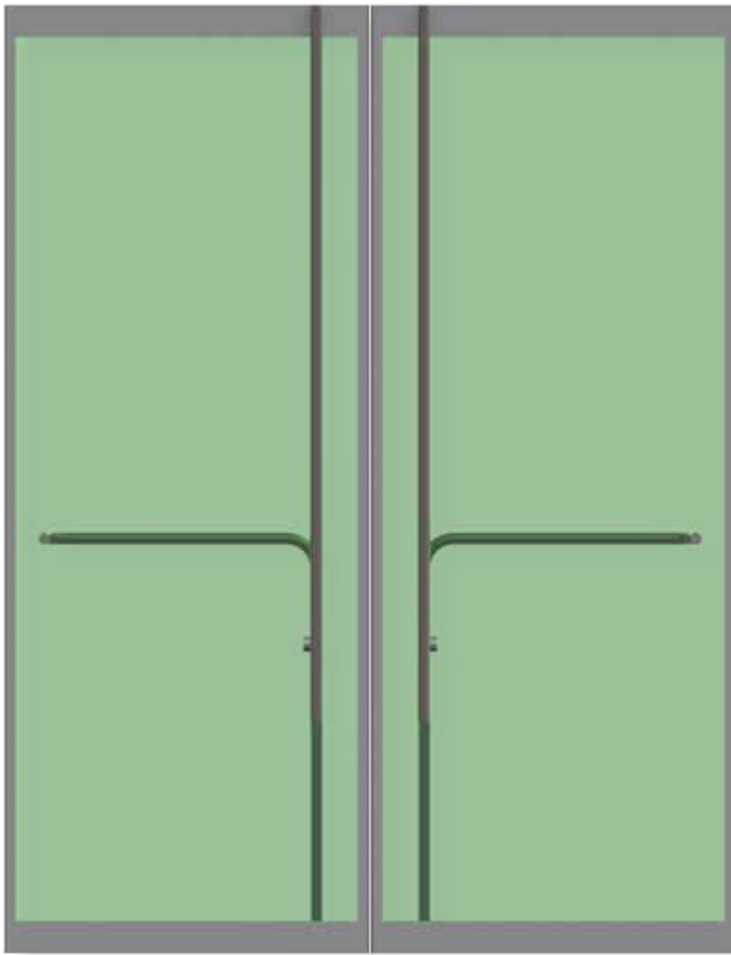

PL110LS

Finish

- #4 brushed stainless steel
- #8 polished stainless steel
- Satin brass
- Polished brass
- us10b
- Custom painted

The following list of mortise cylinders will work with PRL Panics and Deadbolts

MFR.	NO.	NOMINAL LENGTH	CAM NO.
Schlage	20-001	1-1/8"	B502-191
Russwin	#0 1/2"	1-1/8"	#1
Corbin	5253	1-1/8"	#1
Sargent	41	1-1/8"	X13000
Best	1E64	1-1/8"	1EC4
Yale	1152	1-1/8"	1161 (std.)
Lori	218	1-1/8"	4400-00-3002

Removable core mortise cylinders and thumb-turns will function properly when fitted with one of the listed straight cams. Custom cylinder collars are available to accommodate cylinder lengths exceeding 1-1/8"

PRL GLASS SYSTEMS

PL110 PANIC HANDLE CONFIGURATIONS

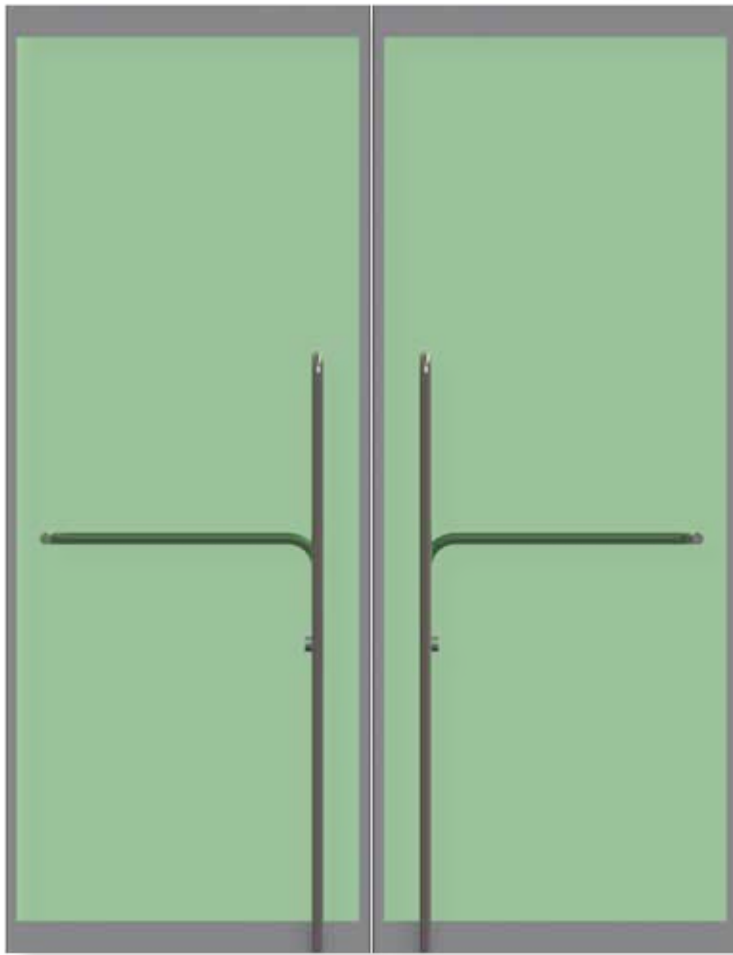

PL110M

Finish

- #4 brushed stainless steel
- #8 polished stainless steel
- Satin brass
- Polished brass
- us10b
- Custom painted

The following list of mortise cylinders will work with PRL Panics and Deadbolts

MFR.	NO.	NOMINAL LENGTH	CAM NO.
Schlage	20-001	1-1/8"	B502-191
Russwin	#0 1/2"	1-1/8"	#1
Corbin	5253	1-1/8"	#1
Sargent	41	1-1/8"	X13000
Best	1E64	1-1/8"	1EC4
Yale	1152	1-1/8"	1161 (std.)
Lori	218	1-1/8"	4400-00-3002

Removable core mortise cylinders and thumb-turns will function properly when fitted with one of the listed straight cams. Custom cylinder collars are available to accommodate cylinder lengths exceeding 1-1/8"

PRL GLASS SYSTEMS

PL110 PANIC HANDLE CONFIGURATIONS

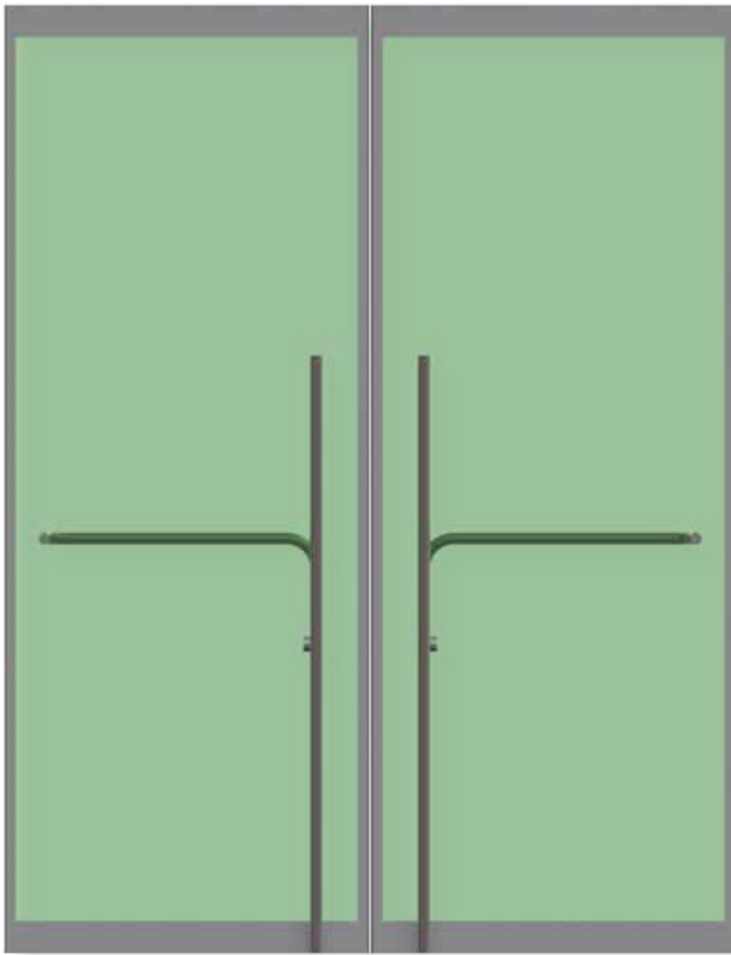

PL110MS

Finish

- #4 brushed stainless steel
- #8 polished stainless steel
- Satin brass
- Polished brass
- us10b
- Custom painted

The following list of mortise cylinders will work with PRL Panics and Deadbolts

MFR.	NO.	NOMINAL LENGTH	CAM NO.
Schlage	20-001	1-1/8"	B502-191
Russwin	#0 1/2"	1-1/8"	#1
Corbin	5253	1-1/8"	#1
Sargent	41	1-1/8"	X13000
Best	1E64	1-1/8"	1EC4
Yale	1152	1-1/8"	1161 (std.)
Lori	218	1-1/8"	4400-00-3002

Removable core mortise cylinders and thumb-turns will function properly when fitted with one of the listed straight cams. Custom cylinder collars are available to accommodate cylinder lengths exceeding 1-1/8"

PRL GLASS SYSTEMS

PL110 PANIC HANDLE CONFIGURATIONS

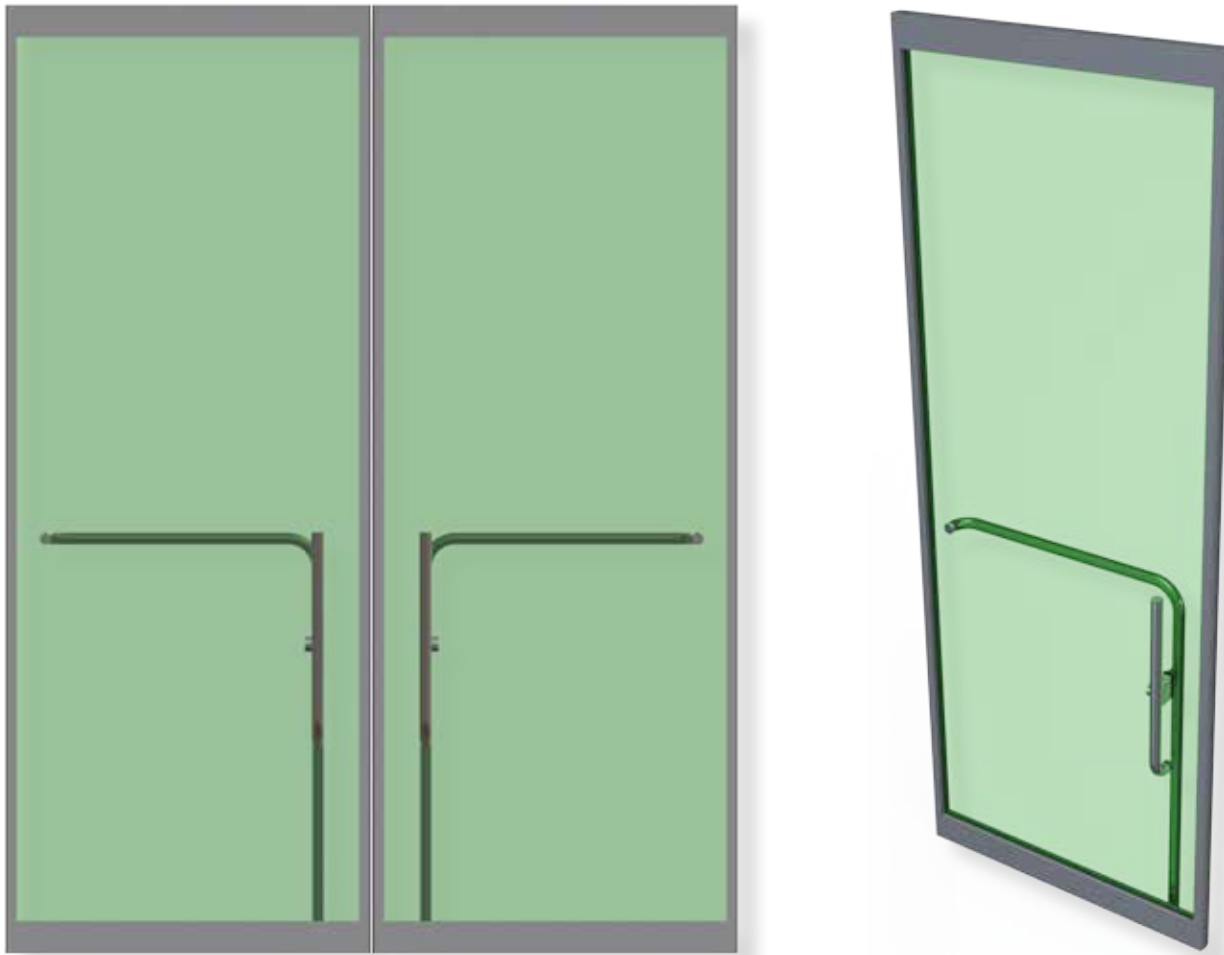

PL110N

Finish

- #4 brushed stainless steel
- #8 polished stainless steel
- Satin brass
- Polished brass
- us10b
- Custom painted

The following list of mortise cylinders will work with PRL Panics and Deadbolts

MFR.	NO.	NOMINAL LENGTH	CAM NO.
Schlage	20-001	1-1/8"	B502-191
Russwin	#0 1/2"	1-1/8"	#1
Corbin	5253	1-1/8"	#1
Sargent	41	1-1/8"	X13000
Best	1E64	1-1/8"	1EC4
Yale	1152	1-1/8"	1161 (std.)
Lori	218	1-1/8"	4400-00-3002

Removable core mortise cylinders and thumb-turns will function properly when fitted with one of the listed straight cams. Custom cylinder collars are available to accommodate cylinder lengths exceeding 1-1/8"

PRL GLASS SYSTEMS

PL110 PANIC HANDLE CONFIGURATIONS

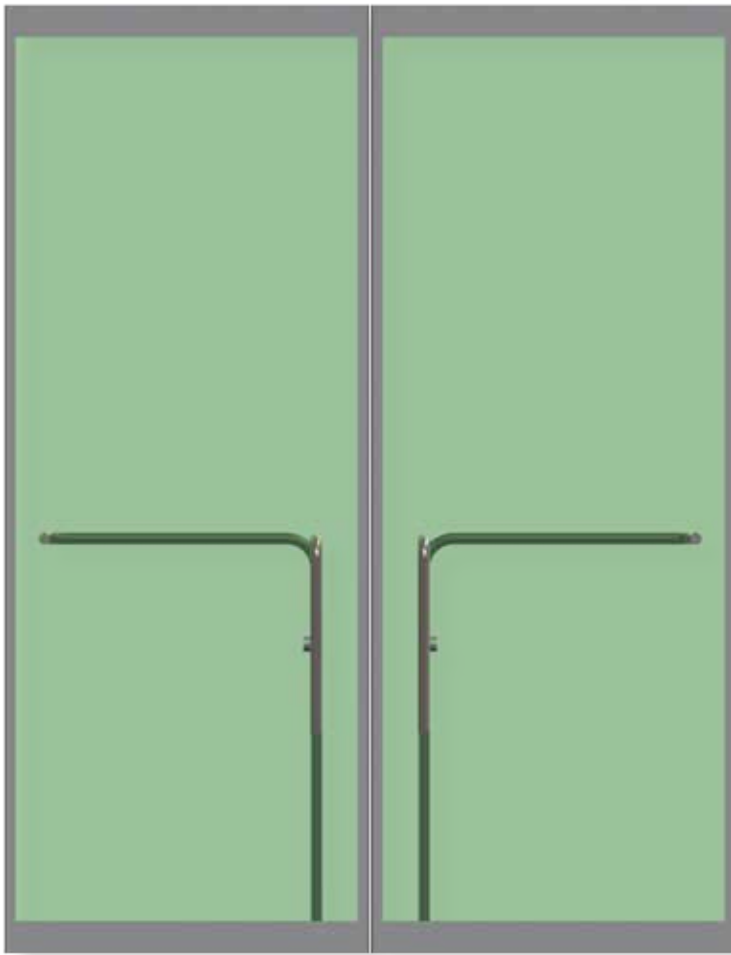

PL110P

Finish

- #4 brushed stainless steel
- #8 polished stainless steel
- Satin brass
- Polished brass
- us10b
- Custom painted

The following list of mortise cylinders will work with PRL Panics and Deadbolts

MFR.	NO.	NOMINAL LENGTH	CAM NO.
Schlage	20-001	1-1/8"	B502-191
Russwin	#0 1/2"	1-1/8"	#1
Corbin	5253	1-1/8"	#1
Sargent	41	1-1/8"	X13000
Best	1E64	1-1/8"	1EC4
Yale	1152	1-1/8"	1161 (std.)
Lori	218	1-1/8"	4400-00-3002

Removable core mortise cylinders and thumb-turns will function properly when fitted with one of the listed straight cams. Custom cylinder collars are available to accommodate cylinder lengths exceeding 1-1/8"

PRL GLASS SYSTEMS

PL110 PANIC HANDLE CONFIGURATIONS

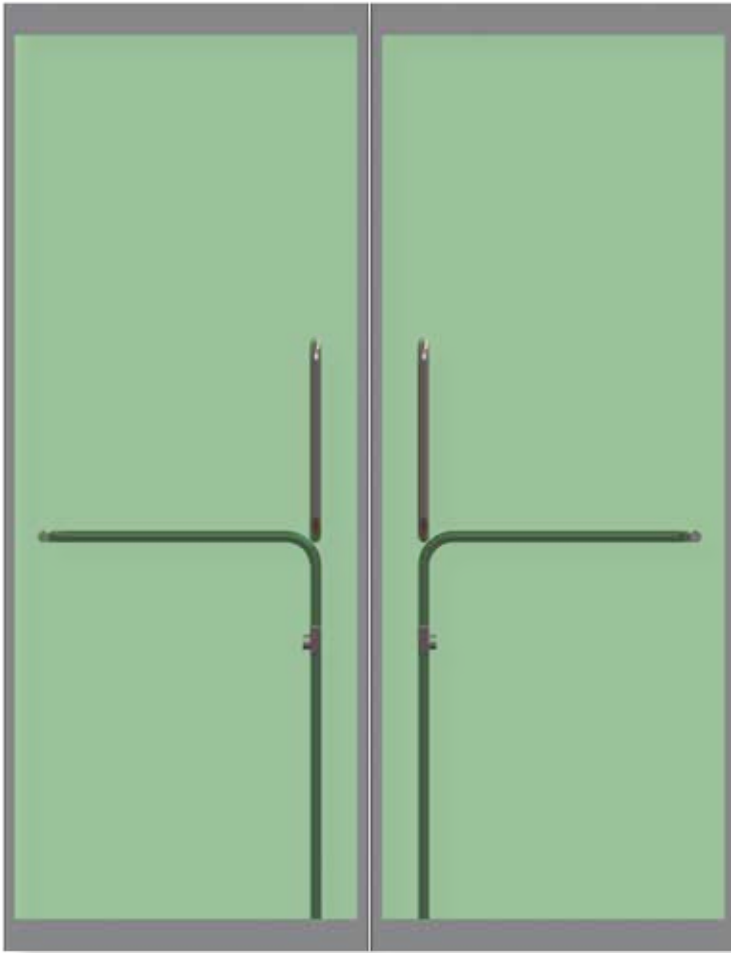

PL110X

Finish

- #4 brushed stainless steel
- #8 polished stainless steel
- Satin brass
- Polished brass
- us10b
- Custom painted

The following list of mortise cylinders will work with PRL Panics and Deadbolts

MFR.	NO.	NOMINAL LENGTH	CAM NO.
Schlage	20-001	1-1/8"	B502-191
Russwin	#0 1/2"	1-1/8"	#1
Corbin	5253	1-1/8"	#1
Sargent	41	1-1/8"	X13000
Best	1E64	1-1/8"	1EC4
Yale	1152	1-1/8"	1161 (std.)
Lori	218	1-1/8"	4400-00-3002

Removable core mortise cylinders and thumb-turns will function properly when fitted with one of the listed straight cams. Custom cylinder collars are available to accommodate cylinder lengths exceeding 1-1/8"

PRL GLASS SYSTEMS

PL110 PANIC HANDLE CONFIGURATIONS

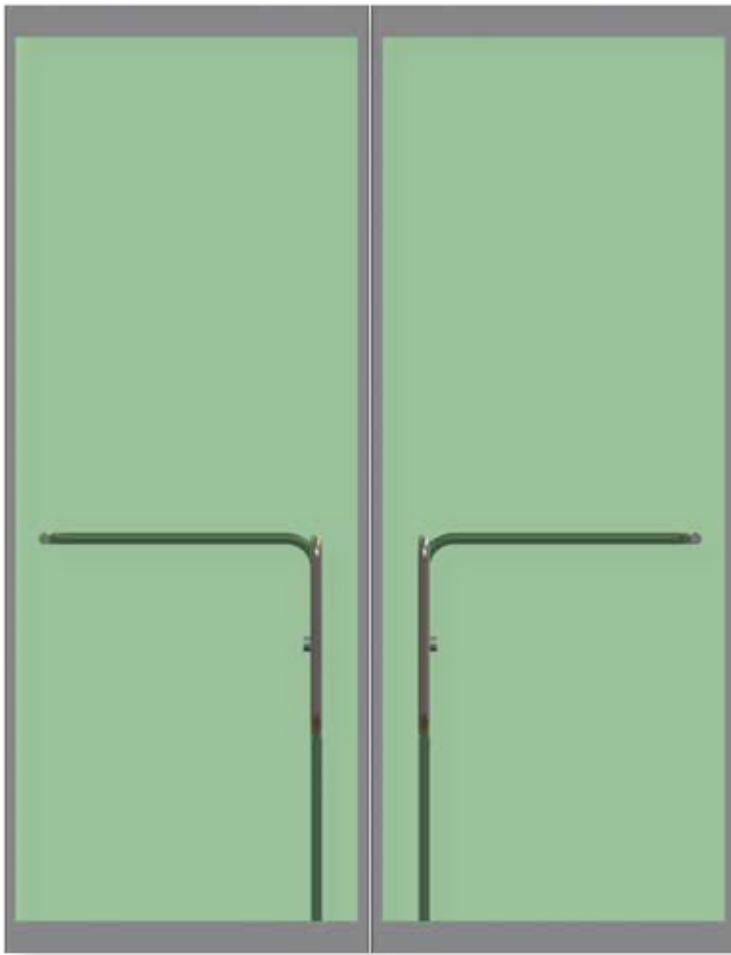

PL110Y

Finish

- #4 brushed stainless steel
- #8 polished stainless steel
- Satin brass
- Polished brass
- us10b
- Custom painted

The following list of mortise cylinders will work with PRL Panics and Deadbolts

MFR.	NO.	NOMINAL LENGTH	CAM NO.
Schlage	20-001	1-1/8"	B502-191
Russwin	#0 1/2"	1-1/8"	#1
Corbin	5253	1-1/8"	#1
Sargent	41	1-1/8"	X13000
Best	1E64	1-1/8"	1EC4
Yale	1152	1-1/8"	1161 (std.)
Lori	218	1-1/8"	4400-00-3002

Removable core mortise cylinders and thumb-turns will function properly when fitted with one of the listed straight cams. Custom cylinder collars are available to accommodate cylinder lengths exceeding 1-1/8"